



BU 0040 – en

Parameterisation units for drive electronics

Manual with installation instructions





Read document and keep for future reference

Read this document carefully prior to performing any work on or putting the device into operation. It is essential to read and observe the instructions in this document. They serve as the prerequisite for smooth and safe operation and the fulfilment of any warranty claims.



Contact Getriebebau NORD GmbH & Co. KG if your questions regarding the handling of the device are not answered in this document or if you require further information.

The German version of this document is the original. The German document is always decisive. If this document is available in other languages, this will be a translation of the original document.

Keep this document in the vicinity of the device so that it is available if required.

Use the version of this documentation that is valid for your device at the time of delivery. You can find the currently valid version of the documentation under www.nord.com.

Please also note the following documents:

- Documentation for the frequency inverter and motor starter
- Catalogue “NORDAC electronic drive technology” ( [E3000](#))
- Documentation for optional accessories ( [Technical data sheets](#)),
- Documentation for equipment which is attached or provided.

Please contact [Getriebebau NORD GmbH & Co. KG](#) if you require further information.

Documentation

Title:	BU 0040
Order no.:	6070402
Device types	SK TU5-CTR, SK TU5-PAR, SK TU3-PAR, SK TU3-CTR, SK PAR-5H/A, SK PAR-3H/E, SK CSX-3H/E
For series:	NORDAC <i>START</i> , NORDAC <i>BASE</i> NORDAC <i>FLEX</i> , NORDAC <i>LINK</i> , NORDAC <i>PRO</i> , NORDAC <i>ON</i>

Version list

Title, Date	Order number	Remarks
BU 0040 , August 2008	6070402 / 3208	• Revised version of issue 4907 (December 2007)
BU 0040 , March 2009	6070402 / 1009	• Addition of the products: – SK PAR-3H – SK CSX-3H
BU 0040 , April 2011	6070402 / 1611	• Restructuring of the manual • Addition of the products:

Title, Date	Order number	Remarks
		<ul style="list-style-type: none"> – SK PAR-3E – SK CSX-3E – SK SSX-3A – SK POT1-1
BU 0040 , January 2013	6070402 / 0113	<ul style="list-style-type: none"> • Addition of the products: <ul style="list-style-type: none"> – SK TU3-CTR – SK TU3-PAR • Supplement of adapter kit for attachment of an SK SSX-3A to the NORDAC <i>FLEX</i> • Revision of the warning and safety information
BU 0040 , December 2023	6070402 / 4923	<ul style="list-style-type: none"> • General corrections • Addition of the products: <ul style="list-style-type: none"> – SK TU5-PAR – SK PAR-5H – SK PAR-5A • Restructuring of the manual • Removal of the products: <ul style="list-style-type: none"> – SK PAR-2H – SK PAR-2E – SK SSX-3A

Table 1: Version list

Other applicable documents

This manual is only valid in conjunction with the operating instructions for the relevant device. All of the information that is required for safe commissioning of the drive application is only available together with this document. A list of these documents can be found in Chapter 8.2 "Further documentation and software".

Copyright notice

As an integral component of the device described here, this document must be provided to all users in a suitable form.

Any editing or amendment or other utilisation of the document is prohibited.

Publisher

Getriebebau NORD GmbH & Co. KG

Getriebebau-Nord-Straße 1 • 22941 Bargteheide, Germany • <http://www.nord.com>

Fon +49 (0) 45 32 / 289-0 • Fax +49 (0) 45 32 / 289-2253

Member of the NORD DRIVESYSTEMS Group

Table of Contents

1	General	8
1.1	Device characteristics	8
1.2	Delivery	11
1.3	Scope of delivery.....	12
1.4	Accessories.....	13
1.5	Intended use	13
1.6	Selection and qualification of personnel.....	14
1.6.1	Qualified personnel.....	14
1.6.2	Qualified electrician	14
1.7	Safety and warning information.....	15
1.8	Explanation of markings.....	16
1.9	Standards and approvals	16
1.10	Type code / nomenclature.....	17
1.10.1	Name plate	17
1.10.2	Type code parameterisation units.....	18
2	Connection and assembly	19
2.1	SK CSX/PAR-3H.....	19
2.1.1	Electrical connection.....	20
2.2	SK PAR-5H.....	21
2.2.1	Mechanical installation in a control panel	21
2.2.2	Electrical connection.....	23
2.3	SK CSX/PAR-3E.....	24
2.3.1	Mechanical installation in a control panel	24
2.3.2	Electrical connection.....	25
2.4	SK PAR-5A	26
2.4.1	Mechanical installation on a NORDAC <i>FLEX</i>	26
2.4.2	Electrical connection.....	28
2.5	SK CSX-3E	30
2.5.1	SK TU3-CTR	30
2.5.2	SK TU3-PAR	30
2.5.3	Mechanical installation on a NORDAC <i>PRO</i> (SK 5xxE)	31
2.6	SK TU5-xxx.....	32
2.6.1	SK TU5-CTR	32
2.6.2	SK TU5-PAR	32
2.6.2.1	Electrical connection to the PC	32
2.6.3	Mechanical installation on a NORDAC <i>PRO</i> (SK 5xxP)	33
3	Display and operation	34
3.1	ParameterBox	34
3.1.1	Display.....	34
3.1.2	Operation.....	36
3.1.3	Controlling the frequency inverter.....	37
3.2	(Simple)ControlBox.....	39
3.2.1	SK CSX-3x and SK TU3-CTR display	40
3.2.2	SK TU5-CTR display	42
3.2.3	Operation.....	44
3.2.4	Control with the (Simple)ControlBox SK CSX-3x and SK TU3-CTR.....	45
3.2.5	Controlling with the ControlBox SK TU5-CTR	46
4	Parameterisation	48
4.1	Parameterisation with the ParameterBox.....	48
4.1.1	Data transfer with NORDCON	50
4.2	Parameterisation with the (Simple)ControlBox.....	53
4.2.1	Parameterisation with the SK TU3-CTR, SK CSX-3H/E	53
4.2.2	Parameterisation with the SK TU5-CTR	55
4.2.3	Menu structure of the (Simple)ControlBox.....	56
5	Parameter	57
5.1	Parameter overview	58
5.1.1	Display.....	59

5.1.2	Parameterisation	62
5.1.3	Param. management	63
5.1.4	Options	65
6	Error an warning messages	67
6.1	Error messages (ControlBox (SK TU5-CTR))	67
6.2	Error messages (ParameterBox).....	67
6.3	Warnings (ParameterBox).....	69
7	Technical data	70
8	Additional information	71
8.1	Assignment parameterisation unit - frequency inverter	71
8.2	Further documentation and software.....	73
9	Maintenance and service notes	74
9.1	Maintenance information.....	74
9.2	Service notes	74
10	Disposal	75
11	List of abbreviations	76

List of illustrations

Figure 1: SK PAR-5H assembly diagram	22
Figure 2: Exploded-view diagram SK PAR-5H assembly	22
Figure 3: SK PAR-5A installation dimensions.....	27
Figure 4: Installation options for the SK PAR-5A on a NORDAC <i>FLEX</i>	27
Figure 5: Electrical connection of the SK PAR-5A to the terminal strip.....	29
Figure 6: NORDCON display: Bus scan	52
Figure 7: Explanation of parameter description	57

1 General

The NORD parameterisation units enable parameterisation, control and display of the operating parameters of the frequency inverters and motor starters from Getriebbau NORD GmbH & Co. KG. They are available in different versions. Further information on the respective properties of the individual units can be found in Chapter 1.1 "Device characteristics".

For information on which parameterisation unit is compatible with which device (frequency inverter / motor starter), see Chapter 8.1 "Assignment parameterisation unit - frequency inverter". A more detailed list can be found in Catalogue  [E3000](#).

In the following, the use of the term **frequency inverter** typically includes the **motor starters**.

1.1 Device characteristics

The parameterisation units are available in different device variants. Below you will find an overview of the different functions or features of the individual units.

Product type	SK PAR-3H SK PAR-5H	SK PAR-3E SK PAR-5A	SK CSX-3H	SK CSX-3E
Variant	Handheld	Installation / attachment	Handheld	Installation
Category	ParameterBox	ParameterBox	Simple ControlBox	Simple ControlBox
Function / feature	Legend			
	✓ = Present		* = Not present	
Operation	✓	✓	✓	✓
Parameterisation	✓	✓	✓	✓
Plain text display	✓	✓	✗	✗
LCD graphics screen (illuminated)	✓	✓	✗	✗
4-digit 7-segment display	✗	✗	✓	✓
Control keypad	✓	✓	✓	✓
LED display				
Parameter set	✓	✓	✓	✓
Device status	✓	✓	✗	✗
Large display for individual operating parameters	✓	✓	✓ ¹⁾	✓ ¹⁾
Scaling of individual operating parameters for display	✓	✓	✗	✗
Language-dependant operation (see parameter P1301))	✓	✓	✗	✗
Plain text display of error messages	✓	✓	✗	✗
ControlBox function possible	✓	✓	✗	✗
Internal memory for 5 complete device data sets	✓ ²⁾	✓ ²⁾	✗	✗
Control of up to 5 networked devices	✓	✓	✗	✗
Automatic device recognition (RS485)	✓	✓	✗	✗
Interface				
RS485	✓	✓	✓	✓
RS232	✓	✗	✗	✗
USB	✓	✓ ³⁾	✗	✗
5 V DC or 24 V DC power supply can be used by the device	✓	✓	✓	

- 1) Restriction: display only for one selectable operating parameter
 2) For SK PAR-3H / -3E, only 3 parameter sets can be stored.
 3) Only SK PAR-5A

Product type	SK TU3-PAR	SK TU5-PAR	SK TU3-CTR	SK TU5-CTR
Variant	Plug-on	Plug-on	Plug-on	Plug-on
Category	ParameterBox	ParameterBox	ControlBox	ControlBox
Function / feature	Legend			
	✓ = Present		x = Not present	
Operation	✓	✓	✓	✓
Parameterisation	✓	✓	✓	✓
Plain text display	✓	✓	x	x
LCD graphics screen (illuminated)	✓	✓	x	x
4-digit 7-segment display	x	x	✓	✓
5-digit 7-segment display	x	✓	x	x
Control keypad	✓	✓	✓	✓
LED display				
Parameter set	✓	✓	✓	✓
Device status	✓	✓	x	x
Large display for individual operating parameters	✓	✓	✓ 1)	✓ 1)
Scaling of individual operating parameters for display	✓	✓	x	x
Language-dependant operation (see parameter P1301))	✓	✓	x	x
Plain text display of error messages	✓	✓	x	x
ControlBox function possible	✓	✓	x	x
Number of parameter sets that can be saved	3	5	1	0
Control of up to 5 networked devices	✓	✓	x	x 3)
Automatic device recognition (RS485)	✓	✓	x	x
Interface				
RS485	x	x	x	x
SPI bus	✓	✓	✓	✓
USB	x	✓	x	x

- 1) Restriction: display only for one selectable operating parameter
- 2) Restriction: only 24 V DC power supply can be used by the device
- 3) Restriction: control of only one device

1.2 Delivery

Examine the device for transport damage or loose components **immediately** on delivery / unpacking. In case of damage, contact the carrier immediately and arrange for a careful survey.

Important! This also applies if the packaging is undamaged.

NOTICE

Defect in the device

If the device is connected to the incorrect frequency inverter or operated with the incorrect accessories, this will cause damage to the device.

- Only use the device with frequency inverters and accessories which are explicitly intended for use with this device and which are stated in these instructions.
-

1.3 Scope of delivery

Standard version



The delivery includes one of the devices listed below:

Type	Part number	Remarks
SK PAR-5H 	275281614	<ul style="list-style-type: none"> • Connection cable, installed: <ul style="list-style-type: none"> – RJ12, length approx. 1.5 m
SK PAR-5A 	275281714	
SK PAR-3E 	275281414	<ul style="list-style-type: none"> • Including connection cable: <ul style="list-style-type: none"> – RJ12-RJ12, length approx. 2 m
SK PAR-3H 	275281014	<ul style="list-style-type: none"> • Including connection cable: <ul style="list-style-type: none"> – RJ12-RJ12, length approx. 2 m – USB, length approx. 1 m
SK CSX-3E 	275281413	<ul style="list-style-type: none"> • Including connection cable: <ul style="list-style-type: none"> – RJ12-RJ12, length approx. 2 m
SK CSX-3H 	275281013	<ul style="list-style-type: none"> • Including connection cable: <ul style="list-style-type: none"> – RJ12-RJ12, length approx. 2 m
SK TU3-CTR 	275900090	<ul style="list-style-type: none"> • Only NORDAC PRO (SK 5xxE)
SK TU3-PAR 	275900100	<ul style="list-style-type: none"> • Only NORDAC PRO (SK 5xxE)
SK TU5-CTR 	275297000	<ul style="list-style-type: none"> • Only NORDAC PRO (SK 5xxP)
SK TU5-PAR 	275297100	<ul style="list-style-type: none"> • Only NORDAC PRO (SK 5xxP)

1.4 Accessories

An overview on options and accessories can be found in the “NORDAC – Electronic drive technology” ([E3000](#)) catalogue. This catalogue is available for download on our website www.nord.com.

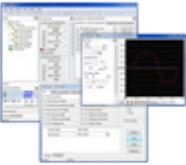
Available accessories:

Designation		Example	Description
Software (Free download)	NORDCON MS Windows® - based software		For commissioning, parametrisation and control of the inverter www.nord.com NORDCON
	ePlan macros		Macros for producing electrical circuit diagrams www.nord.com ePlan
Cable	USB cable	 Part No.: 275292100	Connects the parameterisation unit with a PC / laptop SK CE-USB-C-PC-USB-3m

1.5 Intended use

The parameterisation units are intended for parameterisation, control and display of the operating parameters of the frequency inverters and motor starters from Getriebebau NORD GmbH & Co. KG.

They have been developed and configured for use with the following frequency inverters from Getriebebau NORD GmbH & Co. KG.

Parameterisation unit	Frequency inverters	Assembly type
SK PAR-3H	NORDAC <i>FLEX</i> , NORDAC <i>PRO</i> , NORDAC <i>LINK</i> , NORDAC <i>OM</i> , NORDAC <i>BASE</i> , NORDAC <i>START</i>	Handheld
SK CSX-3H		
SK PAR-5H		
SK PAR-3E	NORDAC <i>PRO</i>	Control cabinet installation
SK CSX-3E		
SK PAR-5A	NORDAC <i>FLEX</i>	Mounting to the frequency inverter
SK TU3-PAR	NORDAC <i>PRO</i> (SK 5xxE)	Plugging on the frequency inverter
SK TU3-CTR		
SK TU5-PAR	NORDAC <i>PRO</i> (SK 5xxP)	Plugging on the frequency inverter
SK TU5-CTR		

1.6 Selection and qualification of personnel

The parameterisation units may only be installed and commissioned by qualified electricians.

1.6.1 Qualified personnel

Qualified personnel includes persons who due to their specialist training and experience have sufficient knowledge in a specialised area and are familiar with the relevant occupational safety and accident prevention regulations as well as the generally recognised technical rules.

These persons must be authorised to carry out the necessary work by the operator of the system.

1.6.2 Qualified electrician

An electrician is a person who, because of their technical training and experience, has sufficient knowledge with regard to

- Switching on, switching off, isolating, earthing and marking power circuits and devices,
- Proper maintenance and use of protective devices in accordance with defined safety standards.
- Emergency treatment of injured persons.

1.7 Safety and warning information

Use the parameterisation units and frequency inverters from the NORD DRIVESYSTEMS Group only for their intended purpose (see chapter 1.5 "Intended use" on page 13).

To ensure safe operation of the parameterisation units, observe all of the instructions in this manual, and in particular the warning information in the other applicable documents (see chapter 8.2 "Further documentation and software" on page 73).

Only commission the parameterisation units in their technically unchanged form and not without the necessary covers. Make sure that all connections and cables are in perfect condition.

Work on and with the parameterisation unit must only be carried out by qualified personnel (see chapter 1.6 "Selection and qualification of personnel" on page 14).

For power supply and operation of the system

- The parameterisation units are operated with electric power, so that in principle there is a risk of electric shock. Therefore, never immerse the parameterisation units in water or other liquids. Keep them away from rain and moisture.
- During parameterisation, take precautions to prevent accidental movement of the drive (e.g. dropping of lifting equipment).
- Never enter the danger area of the system.

For incorrect use

The parameterisation units are only safe if they are used as intended! Incorrect use may cause damage. Therefore, please note the following:

- Only use the parameterisation units for their intended purpose.
- Never connect the parameterisation units to an RJ12 port and a USB port simultaneously.
- Only plug the RJ12 connector of the parameterisation units into the RJ12 socket of the device.
- Only use the USB port of the parameterisation units for connection with NORDCON.
- Only transfer data to the device when it is not enabled.
- Do not interrupt the data transfer.

1.8 Explanation of markings

DANGER

Indicates an immediate danger, which may result in death or very serious injury if it is not avoided.

WARNING

Indicates a dangerous situation, which may result in death or serious injury if it is not avoided.

CAUTION

Indicates a dangerous situation, which may result in minor injuries if it is not avoided.

NOTICE

Indicates a situation, which may result in damage to the product or its environment if it is not avoided.

Information

Indicates hints for use and especially important information to ensure reliability of operation.

1.9 Standards and approvals

The parameterisation units are certified via the devices listed in Chapter 1.5 "Intended use".

For details on this, please refer to the corresponding manuals of the relevant device series (see chapter 8.2 "Further documentation and software" on page 73).

1.10 Type code / nomenclature

Unique type codes have been defined for the individual parameterisation units, giving details of the device type, its electrical data, protection class and mounting variant A distinction is made between the following groups:



ParameterBox (handheld)



ControlBox (plug-on variant)

1.10.1 Name plate

All information which is relevant for the device, including information for the identification of the device, can be obtained from the name plate.



Type: SK TU5-PAR
 Part-No: 275297100
 ID: 46W309063149

Version: AA
 V 0.9

Type:	Type / designation
Part-No:	Material number
ID:	Identification number
Version:	Hardware / software version

1.10.2 Type code parameterisation units

SK TU5-PAR

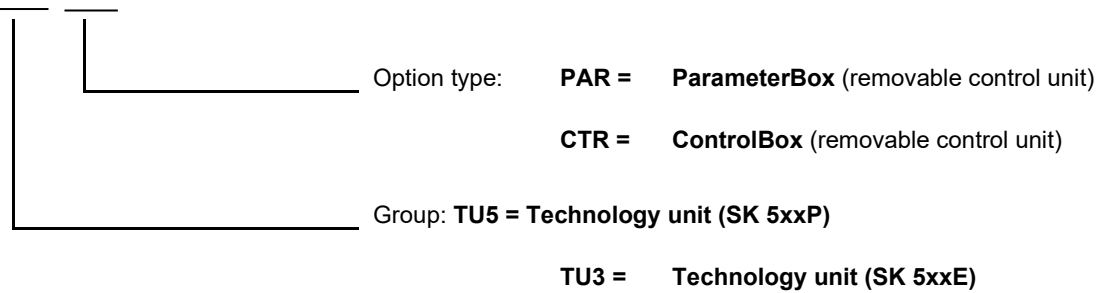

SK PAR-5H

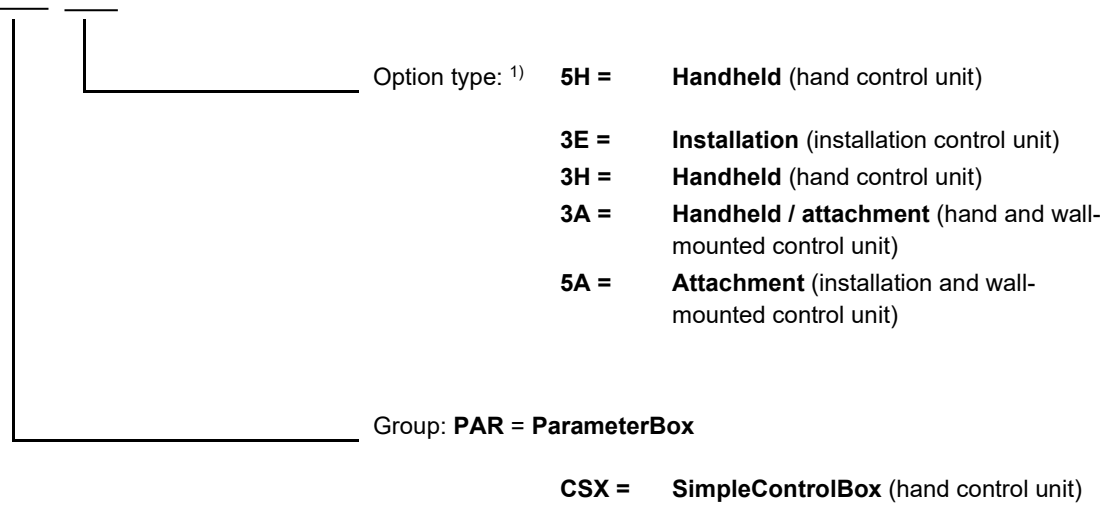

1) Option type **5A**, **5H** newer variant, **3E**, **3H** older variant

2 Connection and assembly

2.1 SK CSX/PAR-3H

SK CSX-3H

The SK CSX-3H SimpleControlBox is a compact control device for direct connection to the frequency inverter with RJ12 diagnostics socket. A standard RJ12 patch cable (modular cable RJ12 (6/6) - RJ12 (6/6), 1:1 assigned) with a length of up to 3 m can be used as the connection cable.

If the SimpleControlBox is supplied by a voltage source with a higher voltage (e.g. 24 V DC from the SK 200E), the cable can also be significantly longer.



SK PAR-3H

The SK PAR-3H ParameterBox is a compact parameterisation unit for direct connection to the frequency inverter with RJ12 diagnostics socket. A standard RJ12 patch cable (modular cable RJ12 (6/6) - RJ12 (6/6), 1:1 assigned) with a length of up to 3 m can be used as the connection cable.

If the ParameterBox is supplied by a voltage source with a higher voltage (e.g. 24 V DC from the SK 200E), the cable can also be significantly longer.

For connection to a PC / laptop, a standard USB device connection cable (USB 2.0 connection cable plug series A to plug series B) is required.



NOTICE

Damage to the PC

The SK PAR-3H/-5H/-5A and SK TU5-PAR ParameterBox must never be connected to a device and to the PC at the same time, as this may result in damage, in particular to the PC.

2.1.1 Electrical connection

The **SK CSX-3H** and **SK PAR-3H** parameterisation units are connected to a frequency inverter exclusively via the RJ12 socket. This connection is also used for the unit's power supply. A terminating resistor (220 Ω) for the RS485 bus system is integrated in the module. Therefore, the parameterisation unit should only be integrated as the first or last participant.

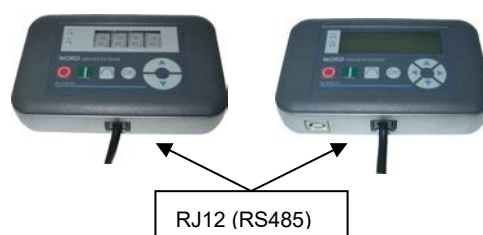

The **SK PAR-3H** parameterisation unit is connected to a PC via the unit's integrated USB interface. This connection is also used for the unit's power supply.

The necessary driver software for the USB interface on the PC is supplied with the enclosed "EPD" CD but is also available free of charge on our internet page (www.nord.com).



The connection to the respective frequency inverters is made via the RJ12 connection sockets provided at the device (see chapter 8.2 "Further documentation and software" on page 73). The SK CSX-3H SimpleControlBox communicates exclusively with frequency inverters.

2.2 SK PAR-5H

The SK PAR-5H ParameterBox is a compact parameterisation unit for direct connection to the frequency inverter or installation in a control cabinet or a control panel. The connection cable is permanently installed on one side of the parameterisation unit and equipped with a RJ12 plug on the other side. The length of the connection cable is 1.5 m.

For connection to a PC / laptop, a standard USB device connection cable (USB-C) is required.



2.2.1 Mechanical installation in a control panel

For mechanical installation of the SK PAR-5H in the control cabinet door or control panel, proceed as follows:

1. Create a cut-out in the control cabinet door / control panel with the dimensions 20 mm x 28 mm (+/- 1 mm tolerance each). A representation of the cut-out can be seen in the following figure "SK PAR-5H assembly diagram".
2. Make 4 holes with a diameter of 3.5 mm in the control cabinet door / control panel. The distances between the holes are 65 mm on each side. The exact positioning of the holes can be seen in the following figure.
3. Loosen the four screws from the corners on the back of the ParameterBox.
4. Now disassemble the ParameterBox into a housing top and bottom part. The connection cable is permanently installed in the housing bottom part.

Information

The seal between the housing top and bottom part is not permanently mounted to the box. It can become detached. Please note that the seal must later be placed between the control cabinet / control panel and the housing top part.

5. Position the housing top part on the outside of the control cabinet / control panel above the cut-out.
6. On the inside of the control cabinet / control panel, hold the bottom part of the ParameterBox housing in front of the cut-out and the holes.
7. Insert the PCB connector, which is located in the housing bottom part, through the cut-out in the control cabinet / control panel into the socket located in the housing top part.
8. Place the housing top and bottom part exactly over the holes.
9. Take the previously loosened screws.
10. Screw the housing bottom and top parts back together.

The parameterisation unit is now permanently mounted to the control cabinet door / control panel and – when correctly mounted – has a protection class of IP44.

Information on the electrical connection of the SK PAR-5H can be found in the following Chapter 2.2.2 "Electrical connection".

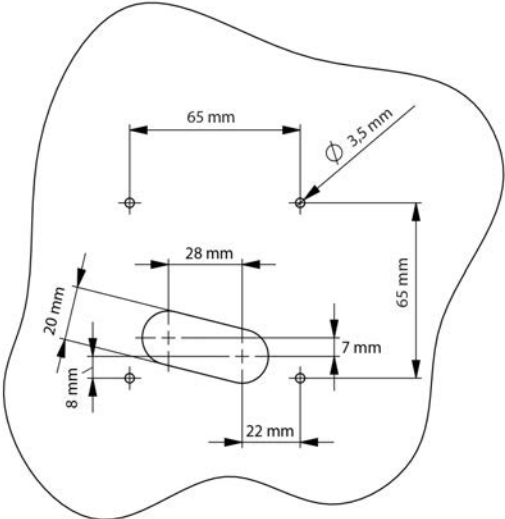

Figure 1: SK PAR-5H assembly diagram

Front view

Back view



Figure 2: Exploded-view diagram SK PAR-5H assembly

2.2.2 Electrical connection

NOTICE

Possible malfunction and damage to the ParameterBox in case of incorrect connection

To avoid damage to the ParameterBox, do not connect the ParameterBox to a PC and a frequency inverter in parallel.

Connection to a PC

The ParameterBox (communication and power supply) is connected by means of a standard **USB/USB-C** connection cable via the USB interface (USB-C) of the ParameterBox.

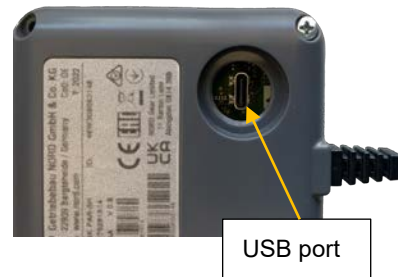

Connection to the frequency inverter

The ParameterBox is connected to the RJ12 connection socket of the frequency inverter via its connection cable (see chapter 8.2 "Further documentation and software" on page 73).

2.3 SK CSX/PAR-3E

SK CSX-3E

The SK CSX-3E SimpleControlBox is a compact control device for installation in a control panel and direct connection to the frequency inverter with RJ12 diagnostics socket. A standard RJ12 patch cable (modular cable RJ12 (6/6) - RJ12 (6/6), 1:1 assigned) with a length of up to 3 m can be used as the connection cable.

If the SimpleControlBox is supplied by a voltage source with a higher voltage (e.g. 24 V DC from the SK 200E), the cable can also be significantly longer.



SK PAR-3E

The SK PAR-3E ParameterBox is a compact parameterisation unit for installation in a control panel and direct connection to the frequency inverter with RJ12 diagnostics socket. A standard RJ12 patch cable (modular cable RJ12 (6/6) - RJ12 (6/6), 1:1 assigned) with a length of up to 3 m can be used as the connection cable.

If the ParameterBox is supplied by a voltage source with a higher voltage (e.g. 24 V DC from the SK 200E), the cable can also be significantly longer.



2.3.1 Mechanical installation in a control panel

For mechanical installation of the SK xxx-3E in the control cabinet door or control panel, proceed as follows:

1. Create a cut-out in the control cabinet door or control panel with the dimensions 109 mm x 64 mm (+/-1 mm tolerance each).
2. Insert the closed unit into the previously machined board of the switching station.
3. Fix the unit on the inside of the control panel with the supplied 6 setscrews (M4 x 16 mm with approx. 7 mm projection when mounted) and the matching nuts.

The parameterisation unit is now permanently mounted to the control cabinet door / control panel and – when correctly mounted – has a protection class of IP54 at the front.

Information on the electrical connection of the SK PAR-3E or SK CSX-3E can be found in the following Chapter (see chapter 2.3.2 "Electrical connection").

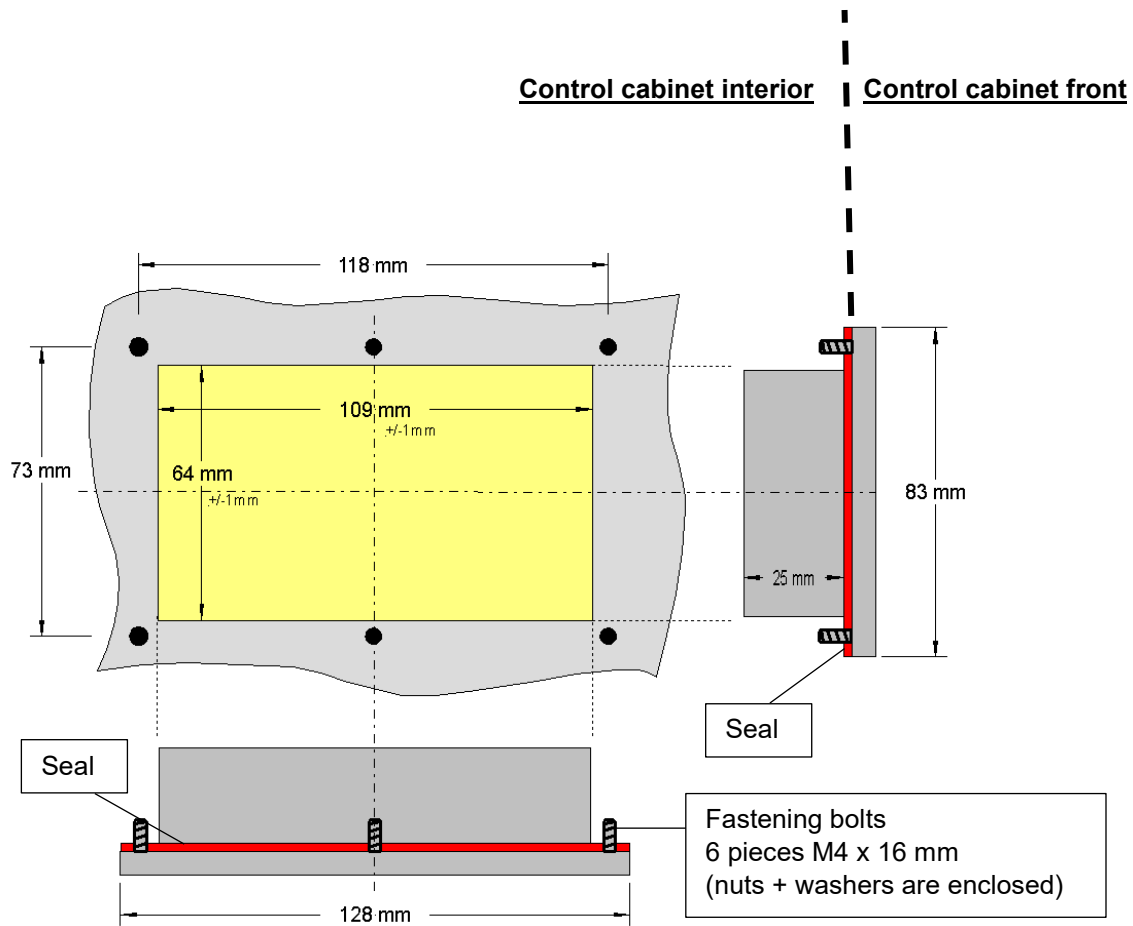

2.3.2 Electrical connection

The **SK CSX-3E** and **SK PAR-3E** parameterisation units are connected to a frequency inverter exclusively via the RJ12 socket. This connection is also used for the unit's power supply.

A terminating resistor (220 Ω) for the RS485 bus system is integrated in the module. Therefore, the ParameterBox should only be integrated as the first or last participant.

In contrast to the SK PAR-3H handheld variant, the connection of the SK PAR-3E ParameterBox to a PC is not possible.

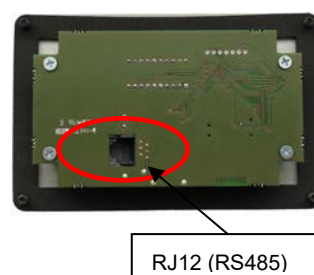

Parameterisation unit back side
Similar to figure

The connection to the respective frequency inverters is made via the RJ12 connection sockets provided at the device (see chapter 8.2 "Further documentation and software" on page 73). The SK CSX-3E SimpleControlBox communicates exclusively with frequency inverters.

2.4 SK PAR-5A

The SK PAR-5A ParameterBox is a compact parameterisation unit for attachment to the NORDAC *FLEX* on an M25 cable gland. The assembly and electrical connection are carried out directly at the frequency inverter. The electrical connection is made via connection to the control terminal in the NORDAC *FLEX*. This is also the power supply of the ParameterBox.



2.4.1 Mechanical installation on a NORDAC *FLEX*

The SK PAR-5A is intended for mechanical installation on a NORDAC *FLEX* (SK 2xxE). If you decide on a SK PAR-5A as a parameterisation unit with direct installation, you should already take this into account during the project planning. The ParameterBox is mounted on an M25 cable gland and thus partially blocks the installation of further optional modules. Two installation options for the SK PAR-5A on a NORDAC *FLEX* are shown in the following figure. For the individual option slots on the device, refer to [BU 0200](#).

For mechanical installation of the SK PAR-5A on the NORDAC *FLEX*, proceed as follows as an example:

1. Remove the frequency inverter from its connection unit. Observe the instructions in the [BU 0200](#).
2. Remove the sealing plug from an M25 cable gland on the NORDAC *FLEX*.
3. Loosen the union nut from the back of the SK PAR-5A.
4. Guide the electrical connection cables of the SK PAR-5A through the cable gland.
5. Now guide the cables through the hole in the union nut.
6. Insert the thread through the exposed M25 cable gland on the back of the ParameterBox. Make sure that the seal is in place around the thread.
7. From the inside (inside of the NORDAC *FLEX*), screw the union nut back onto the SK PAR-5A

The ParameterBox is now permanently mounted on the NORDAC *FLEX* and – when correctly mounted (in vertical installation position) – has a protection class of IP54.

Information on the electrical connection of the SK PAR-5A can be found in the following Chapter 2.4.2 "Electrical connection".

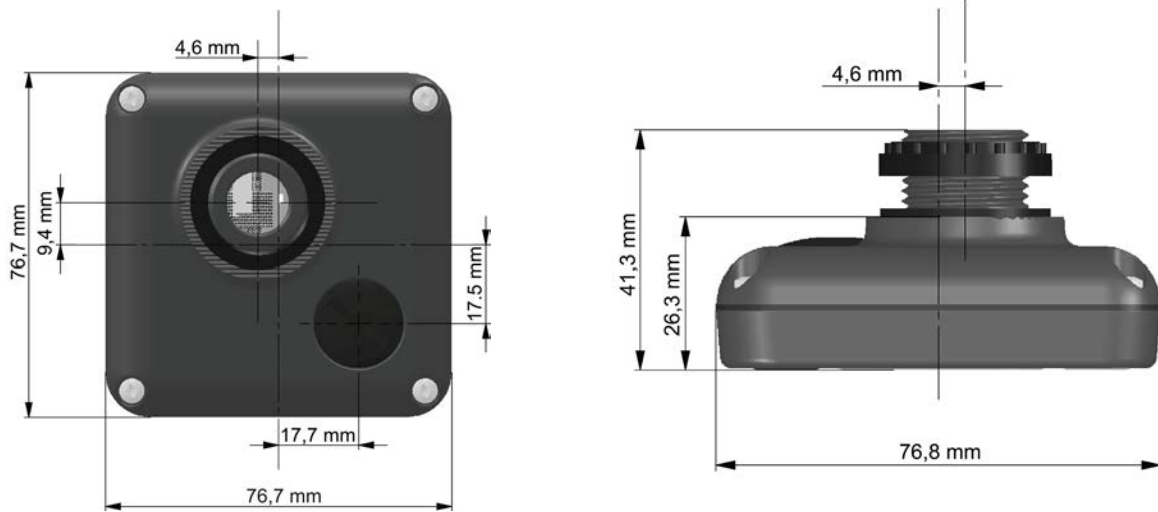

Figure 3: SK PAR-5A installation dimensions



Figure 4: Installation options for the SK PAR-5A on a NORDAC FLEX

2.4.2 Electrical connection

NOTICE

Possible malfunction and damage to the ParameterBox in case of incorrect connection

To avoid damage to the ParameterBox, do not connect the ParameterBox to a PC and a frequency inverter in parallel.

Connection to a PC

The ParameterBox (communication and power supply) is connected by means of a standard **USB/USB-C** connection cable via the USB interface (USB-C) of the ParameterBox.



Connection to the NORDAC FLEX frequency inverter

The ParameterBox is connected inside the frequency inverter's connection unit.

1. Remove the frequency inverter from its connection unit. Observe the instructions in the [BU 0200](#).
2. First, install the SK PAR-5A on an M25 cable gland (see chapter 2.4.1 "Mechanical installation on a NORDAC FLEX" on page 26).
3. Attach the connection cables to the terminal strip in the connection unit according to the figure. Information on the individual connection terminals can be found in the table below (see "Connection terminal details").

NOTICE: Only connect the SK PAR-5A via the system bus! Be sure to insulate the two **unconnected** cables.

Note: A terminating resistor (120 Ω) is integrated.

4. Mount the frequency inverter back onto the connection unit according to the instructions in the [BU 0200](#).

The SK PAR-5A is now connected to the NORDAC FLEX.

Note: If you want to control the frequency inverter by the SK PAR-5A, you must set parameter P509 on the frequency inverter to "System bus".

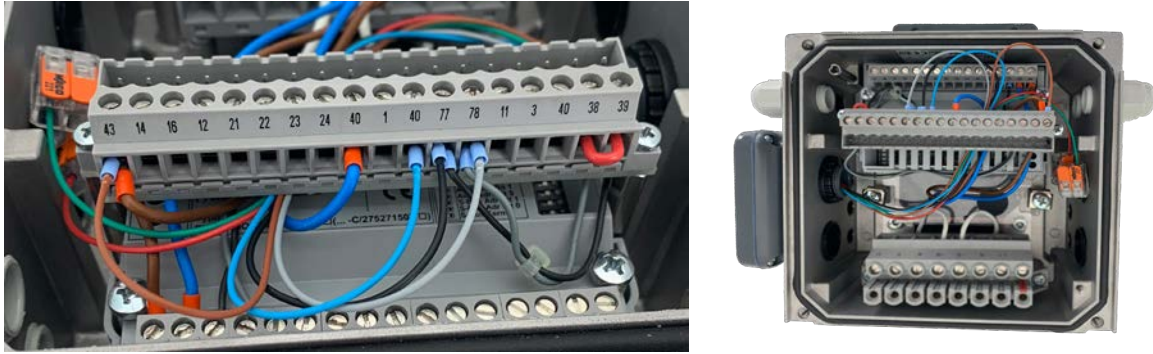

Figure 5: Electrical connection of the SK PAR-5A to the terminal strip

Terminal	Designation	Colour
40	GND	Blue
43	24 V output	Brown
77	SYS H	Black
78	SYS L	Grey
73	RS485+	Green
74	RS485-	rot

Table 2: Connection terminal details

2.5 SK CSX-3E

These technology units are only suitable for use with the NORDAC *PRO* (SK 5xxE).

2.5.1 SK TU3-CTR

The SK TU3-CTR ControlBox is used for commissioning, configuring and controlling the NORDAC *PRO* (SK 5xxE). It is mounted directly on the slot for the technology units. Communication with the frequency inverter and the power supply of the module are provided by a contact rail. The module cannot be used independently from the frequency inverter.

The display is via a 4-digit 7-segment display. Operation is possible via 6 control keys.

It is possible to save the parameters of a frequency inverter ( [BU 0500](#), **P550**).



2.5.2 SK TU3-PAR

The SK TU3-PAR ParameterBox is used for commissioning, configuring and controlling the NORDAC *PRO* (SK 5xxE). It is mounted directly on the slot for the technology units. Communication with the frequency inverter and the power supply of the module are provided by a contact rail. The module cannot be used independently from the frequency inverter.

The display is via a 4-line LED display. Operation is possible via 8 control keys.

It is possible to save the parameters of 3 frequency inverters.



2.5.3 Mechanical installation on a NORDAC PRO (SK 5xxE)

i Information

Das Einsetzen oder Entfernen der Module sollte nur im spannungsfreien Zustand erfolgen. Die Steckplätze sind nur für die dafür vorgesehenen Module nutzbar.

Eine vom Frequenzumrichter entfernte Montage der Technologiebox ist nicht möglich, sie muss unmittelbar am Frequenzumrichter aufgesteckt werden.

The SK TU3-CTR and SK TU3-PAR must be installed as follows:

1. Switch off the mains voltage and observe the waiting period.
2. Push the control terminal cover down slightly or remove it.
3. Remove the blank cover by activating the release mechanism at the lower edge and removing it with an upward rotating movement.
4. Hook the technology unit onto the upper edge and press in lightly until it engages. Make sure that the connector strip makes proper contact and secure it with a matching screw, if required.
5. Close the control terminal cover again.



2.6 SK TU5-xxx

These technology units are only suitable for use with the NORDAC PRO (SK 5xxP).

2.6.1 SK TU5-CTR

The SK TU5-CTR ControlBox is used for commissioning, configuring and controlling the NORDAC PRO (SK 5xxP). It is mounted directly on the slot for technology units or on the SK CU5 module. Communication with the frequency inverter and the power supply of the module are provided by a contact rail. The module cannot be used independently from the frequency inverter.

Display is via an LCD display with 5-digit 7-segment display. Operation is possible via 6 control keys.

It is possible to save the parameters of one frequency inverter.



2.6.2 SK TU5-PAR

The SK TU5-PAR ParameterBox is used for commissioning, configuring and controlling of a frequency inverter from the NORDAC PRO SK 5xxP series. It is mounted directly on the slot for the technology units. Communication with the frequency inverter and the power supply of the module are provided by a contact rail. The ParameterBox cannot be used independently from the frequency inverter. The frequency inverter requires firmware version 1.4R0 or higher.

The display is via a TFT display (2"). Operation is possible via 8 control keys.

It is possible to save the parameters of 5 frequency inverters.



2.6.2.1 Electrical connection to the PC

The ParameterBox (communication and power supply) is connected by means of a standard USB/USB-C connection cable via the USB interface (USB-C) of the ParameterBox.

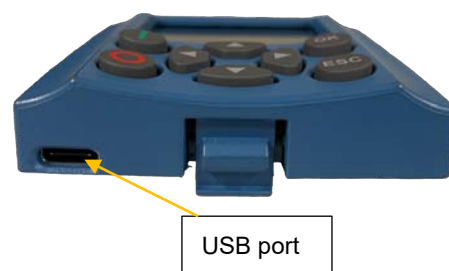

NOTICE

Possible malfunction and damage to the ParameterBox in case of incorrect connection

To avoid damage to the ParameterBox, do not connect the ParameterBox to a PC while it is connected to a frequency inverter.

2.6.3 Mechanical installation on a NORDAC PRO (SK 5xxP)

Information

Das Einsetzen oder Entfernen der Module sollte nur im spannungsfreien Zustand erfolgen. Die Steckplätze sind nur für die dafür vorgesehenen Module nutzbar.

Eine vom Frequenzumrichter entfernte Montage der Technologiebox ist nicht möglich, sie muss unmittelbar am Frequenzumrichter aufgesteckt werden.

The SK TU5-CTR and SK TU5-PAR are to be assembled as follows:

1. Switch off the mains voltage and observe the waiting period.
2. Push the control terminal cover down slightly or remove it.
3. Remove the blank cover by activating the release mechanism at the lower edge and removing it with an upward rotating movement.
4. Hook the technology unit onto the upper edge and press in lightly until it engages. Take care that the connector strip makes proper contact.
5. Close the control terminal cover again.



Blank cover and control terminal cover



SK TU5-CTR



SK CU5-...

3 Display and operation

3.1 ParameterBox

3.1.1 Display

After the ParameterBox has been commissioned for the first time, there will be a request for the menu language, German or English.

An automatic “Bus scan” is carried out subsequently or after each restart of the box. During this, the ParameterBox identifies the connected frequency inverter. The following display shows the frequency inverter type and its current operating status.

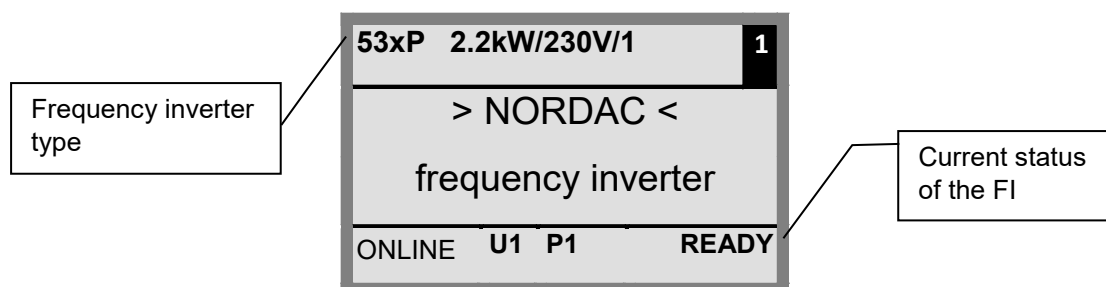

In standard display mode, 3 operating values and the current frequency inverter status can be displayed simultaneously.

The operating values displayed can be selected from a list (in Menu >Display< / >Values to display< (P1004)).

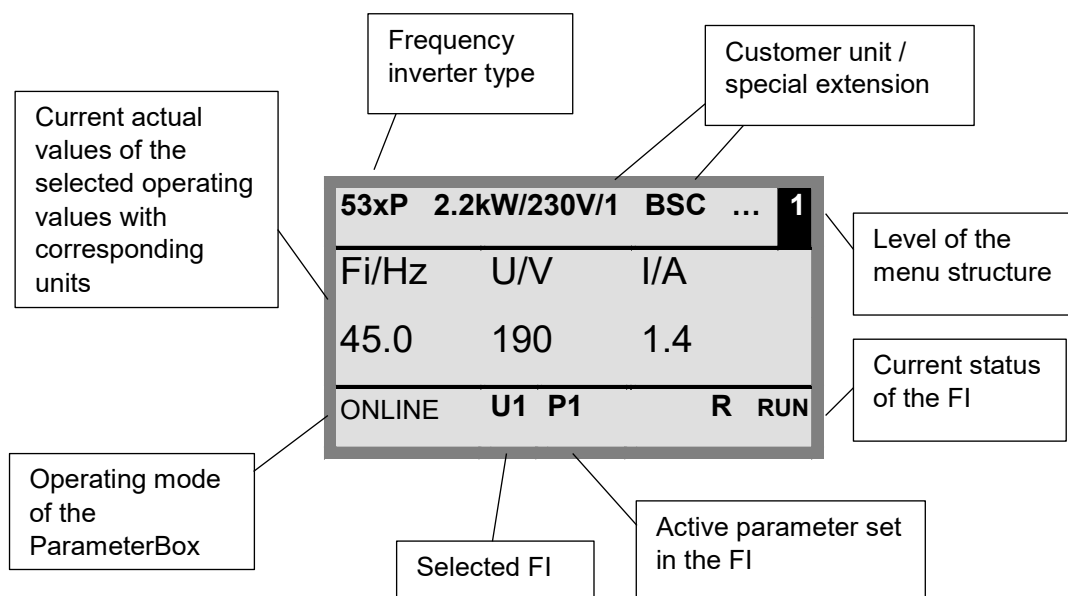

Status window

In the status window of menu level 1, an interface status of all frequency inverters connected to the BUS is displayed.

The USS address, the interface status and the current setpoint of each object are displayed in percent.

Frequency inverter with USS address used	U1	U2	U3	U4	U5
	1	5	30	-	-
Frequency inverter status	OK	OK	ERR	-	-
Current setpoint in %	100	59	0		

ControlBox mode

In addition to the ParameterBox mode, a further display mode (ControlBox) can be selected. If this mode is selected, the ControlBox displays (“LED” display for active parameter set and 4-digit “7-segment display”) are shown. This mode also enables access to new parameters of a frequency inverter, even if these parameters have not yet been implemented in the firmware of the ParameterBox. (Example: An inverter with current firmware version is to be parameterised with a ParameterBox with an older firmware version).

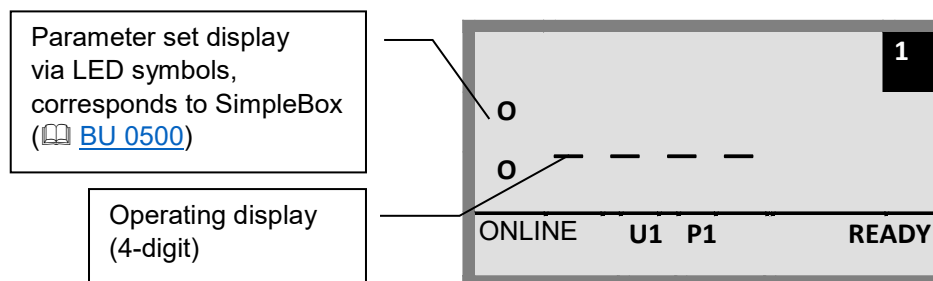

Information

Setpoint













The digital frequency setpoint is factory set to 0 Hz. To check whether the drive is working, a frequency setpoint must be entered via the ▲ or ▼ keys or a jog frequency via the respective parameter **P113** “Jog frequency”.

WARNING

Danger of injury due to motor starting

The drive may start immediately after pressing the START key .

3.1.2 Operation

	Keys	Explanation			
All ParameterBoxes	 Arrow keys (left/right)	Use the arrow keys (left/right) to go through the menu levels and the individual menu items. Simultaneously press the ◀ and ▶ keys to go one level back.			
					
	 Arrow keys (up/down)	The content of individual parameters can be changed with the arrow keys (up/down). Simultaneously press the ▲ and ▼ keys to load the factory setting of the parameter selected.			
		When controlling the inverter with the keyboard, the frequency setpoint is set using the ▲ and ▼ arrow keys.			
	 ENTER key	Press the ENTER key to select a menu group or accept the changed menu items or parameter values. Note: If a parameter is to be exited without saving a changed value, one of the ◀ and ▶ keys can be used for this.			
	 OK	If the frequency inverter is currently controlled via the keyboard (not the control terminals), the current setpoint frequency can be stored in the parameter P113 "Jog frequency".			
	 START key	The START key is used to switch on the frequency inverter.			
	 STOP key	The STOP key is used to switch off the frequency inverter.			
SK TU5-PAR, SK PAR-5x	 ESC key	Changes the direction of rotation if the frequency inverter is enabled. The motor's direction of rotation changes after pressing this keys. "CCW direction of rotation" is indicated by a minus sign. NOTICE: Take care when operating pumps, screw conveyors, fans, etc. → Disabling the key is possible with parameter P540 .			
	 START key				
SK PAR-3x	 Reverse rotation key	The motor's direction of rotation changes after pressing this key. "CCW direction of rotation" is indicated by a minus sign. NOTICE: Take care when operating pumps, screw conveyors, fans, etc. → Disabling the key is possible with parameter P540 .			
	 DS LEDs	The LEDs indicate the current status of the ParameterBox.			
	 DE	<table border="1"> <tr> <td>DS (ON (green)) Device State</td> <td>The ParameterBox is connected to the power supply and ready for operation.</td> </tr> <tr> <td>DE (ERROR (red)) Device Error</td> <td>An error has occurred in the processing or communication of the data or in the connected frequency inverter.</td> </tr> </table>	DS (ON (green)) Device State	The ParameterBox is connected to the power supply and ready for operation.	DE (ERROR (red)) Device Error
DS (ON (green)) Device State	The ParameterBox is connected to the power supply and ready for operation.				
DE (ERROR (red)) Device Error	An error has occurred in the processing or communication of the data or in the connected frequency inverter.				

3.1.3 Controlling the frequency inverter

The frequency inverter's speed and direction of rotation can be fully controlled via the ParameterBox. Depending on the frequency inverter series, different settings are required for this.

Series	Setting P509	Comment
NORDAC BASE	{0} "Contr.term. or keyb."	Control via the ParameterBox is only possible if there is no enable via the control terminals. (First used interface gets the priority.)
NORDAC FLEX	{0} "Contr.term. or keyb."	Control via the ParameterBox is only possible if there is no enable via the control terminals. (First used interface gets the priority.)
NORDAC LINK	{0} "Contr.term. or keyb."	Control via the ParameterBox is only possible if there is no enable via the control terminals. (First used interface gets the priority.)
NORDAC PRO (SK 500E)	For use of a SK PAR-3x or SK PAR-5x:	
	{2} "USS"	No further control via the control terminals or keyboard of a mounted technology unit possible.
	For use of a SK TU3-PAR or SK TU3-CTR:	
	{0} "Contr.term. or keyb."	Control via the ParameterBox is only possible if there is no enable via the control terminals. (First used interface gets the priority.)
NORDAC PRO (SK 500P)	For use of a SK PAR-3x or SK PAR-5x:	
	{2} "USS"	No further control via the control terminals or keyboard of a mounted technology unit possible.
	For use of a SK TU5-CTR or TU5-PAR:	
	{0} "Contr.term. or keyb."	Control via the ParameterBox is only possible if there is no enable via the control terminals. (First used interface gets the priority.)
NORDAC ON	{0} "Contr.term. or keyb."	Control via the ParameterBox is only possible if there is no enable via the control terminals. (First used interface gets the priority.)

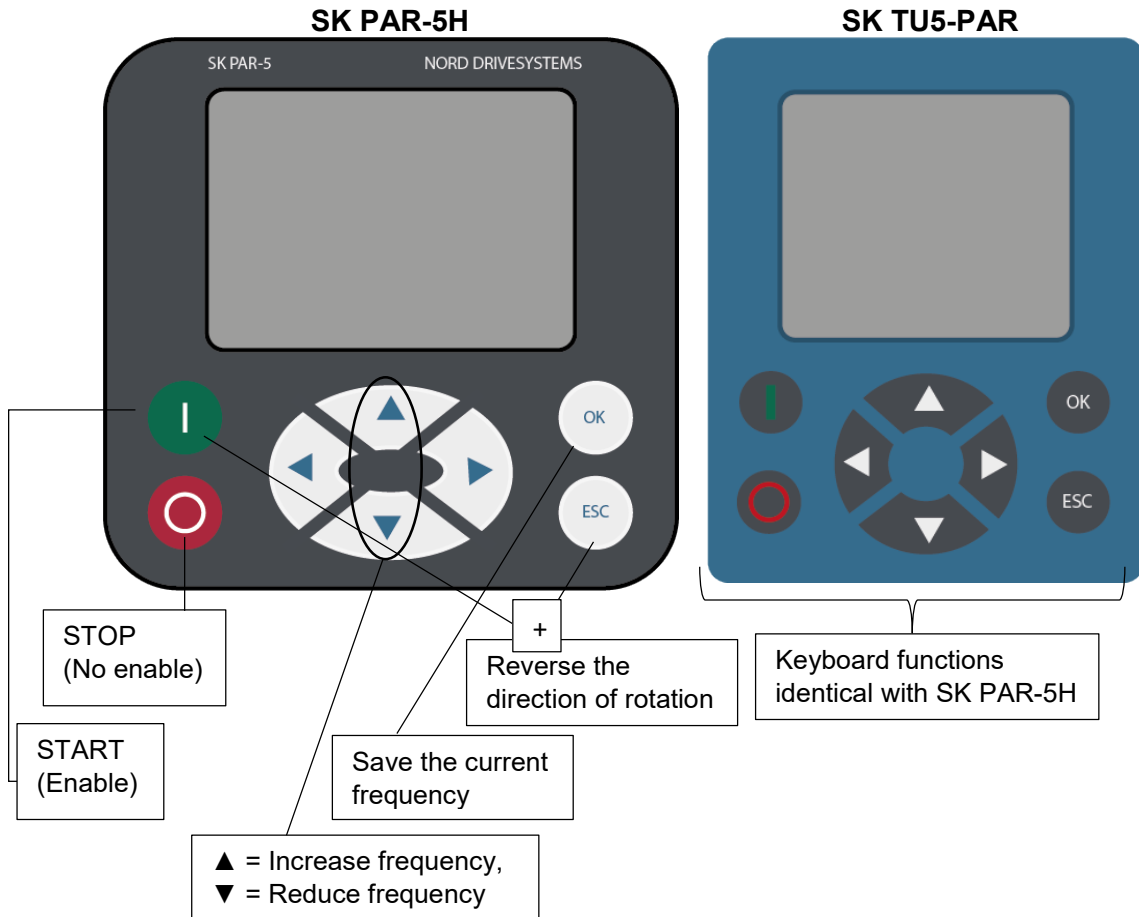

If the frequency inverter is enabled in this mode, the parameter set selected for this frequency inverter in Menu >Parameterization< >Basic parameters< in the >Parameter set< parameter (**P100**) is used. After changing the parameter set during operation, it must be activated with the STOP or reverse rotation key. However, it is safer to carry out the switchover at a standstill.

⚠ WARNING

Danger of injury due to motor starting

The drive may start immediately after pressing the START key !

Menu structure of the ParameterBox

The menu structure consists of various levels that are each arranged in a ring structure. Pressing the ENTER key takes you to the next level. To return, press the ◀ and ▶ arrow keys simultaneously.

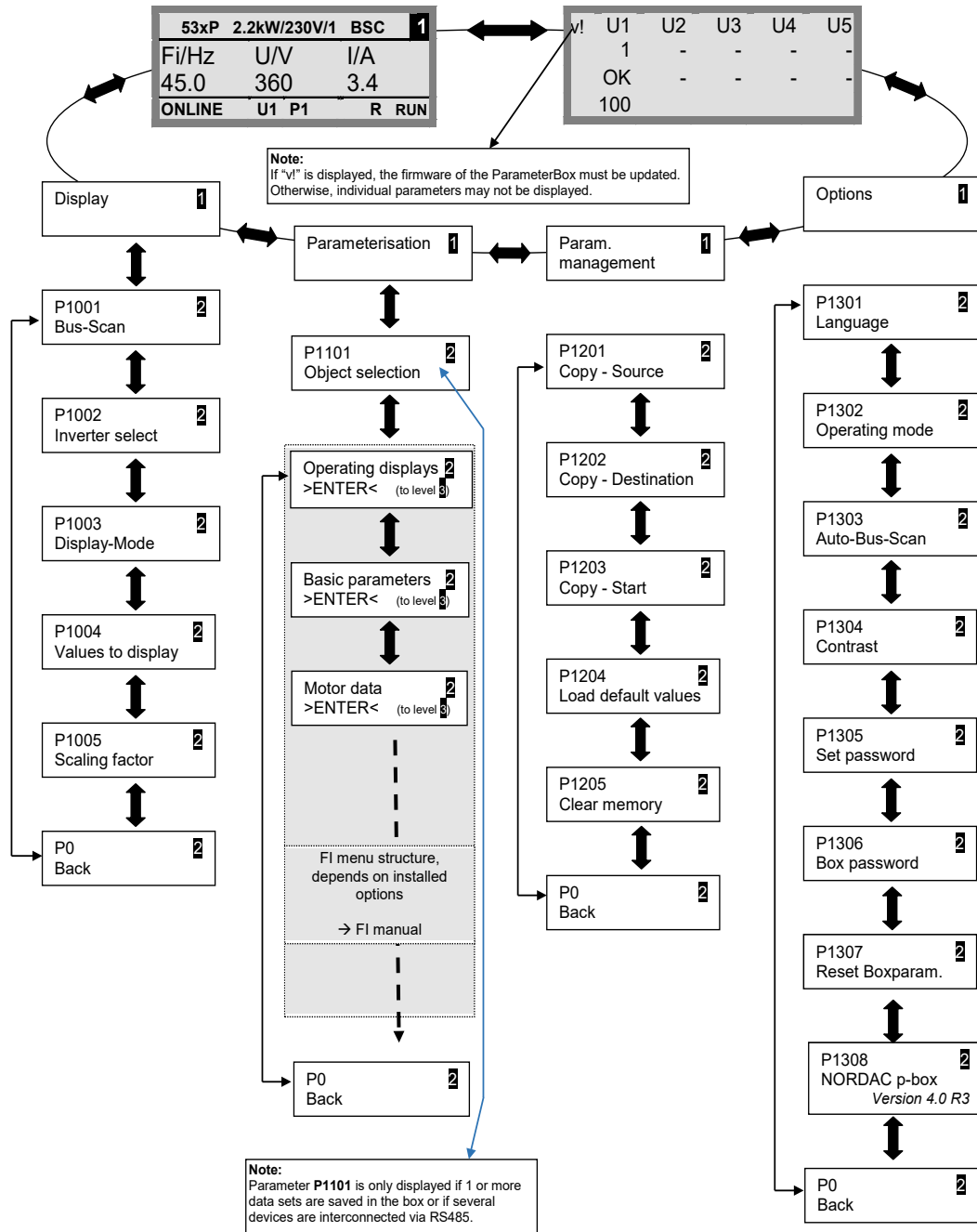

>Display< (P11xx), >Param. management< (P12xx) and >Options< (P13xx) are purely ParameterBox parameters and are not directly related to the frequency inverter parameters.

Access to the menu structure of the frequency inverter is gained via Menu >Parameterization<. The details depend on the equipment of the frequency inverter with customer units (SK CU1-...) and/or special extensions (SK XU1-...). The description of the parameterisation and the parameters can be found in the respective inverter manual.

3.2 (Simple)ControlBox

3.2.1 SK CSX-3x and SK TU3-CTR display

After connecting/assembling the box and switching on the frequency inverter's mains voltage (or the control voltage), communication between the frequency inverter and box is automatically established. After all display segments and diodes of the box flash briefly, a bus scan is carried out. In the meantime, the middle bars in the display (4-digit 7-segment display) may flash with increased frequency.

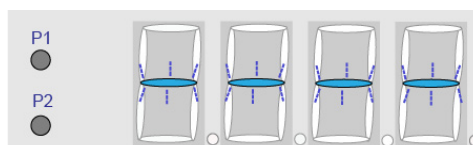

If the bus scan was completed successfully, the power of the frequency inverter appears briefly on the display (e.g.: 0.37 = 0.37 kW). If the box is connected to a frequency inverter that is already in operation, this step will be skipped.

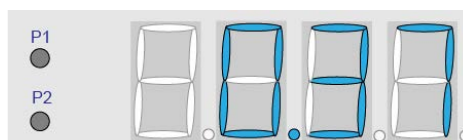

The horizontal lines that then appear in the display indicate that the frequency inverter is ready for operation.

If a jog frequency is preset in parameter **P113** or a minimum frequency is preset in parameter **P104**, the display flashes with this initial value.

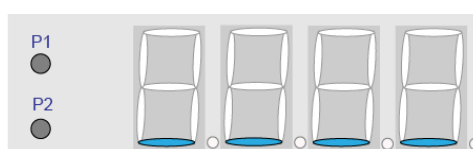

If the frequency inverter is enabled, the display automatically changes to the operating value set in parameter **P001** "Select of disp.value" (factory setting = actual frequency).

The currently used parameter set is indicated in binary code via the 2 LEDs on the left of the display.

After switching off the frequency inverter, "OFF" appears briefly before the display turns off completely.

"OFF" also appears on the display if the SimpleBox is operated on a frequency inverter with external 24 V control voltage feed, but the power supply (230 V or 400 V) is inactive.

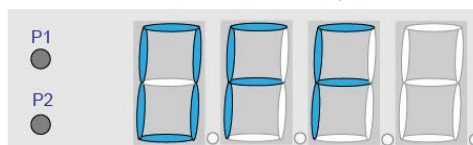

The parameterisation of the inverter (chapter 4.2) can be carried out via the box almost without restriction (no motor resistance measurement or parameter identification (**P208** / **P220**) possible) in this state. However, control (enable) is not possible due to the lack of power supply.

Information

Setpoint







The digital frequency setpoint is factory set to 0 Hz. To check whether the drive is working, a frequency setpoint must be entered via the ▲ or ▼ keys or a jog frequency via the respective parameter **P113** "Jog frequency".

WARNING

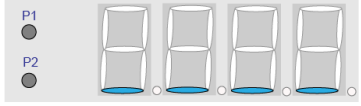
Danger of injury due to motor starting

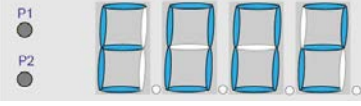
The drive may start immediately after pressing the START key .





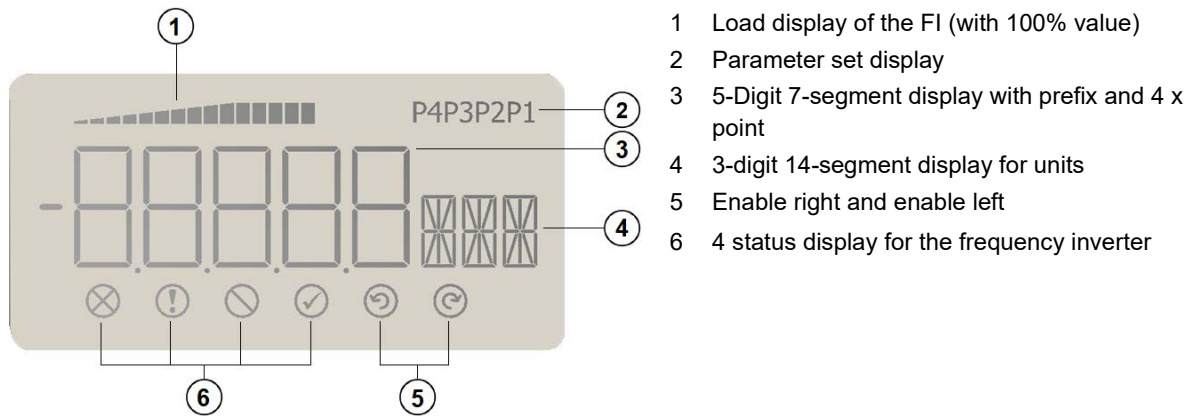

7-segment LED display (4-digit)

Operating mode	Comment	
Ready for operation <ul style="list-style-type: none"> Without present setpoint 		Display of 3 static underscores When underscores are flashing slowly: <ul style="list-style-type: none"> Frequency inverter is not ready for operation (e.g.): <ul style="list-style-type: none"> Switch-on inhibit: Function "Safe pulse block" or "Quick stop active" Enable signal present before the frequency inverter is ready for operation.
Ready for operation <ul style="list-style-type: none"> With present setpoint 		Slow flashing of digits: <ul style="list-style-type: none"> A present initial setpoint (P104 / P113 in keyboard mode, e.g. 5.3 Hz) is indicated. This frequency value is approached immediately after enable.
In operation		Display of the current operating value (e.g. current frequency).
In case of fault		Display of a current and active error message. <ul style="list-style-type: none"> Slow flashing of the display indicates that the error is no longer present and the error message can be acknowledged.
Parameterisation		Display parameter number or parameter value 1. Parameter group (e.g.: motor data (P2xx))
		2. Parameter number (e.g.: Nominal speed (P202))
		3. Parameter value (e.g.: 1360 min ⁻¹)







3.2.2 SK TU5-CTR display









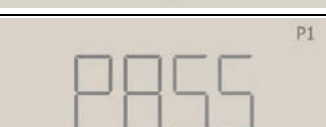











Status displays

	Fault present		FI is ready to switch-on
	Warning present		Enable (rotates left) present
	Switch-on inhibit present		Enable (rotates right) present

7-segment LED display (5-digit)

Operating mode		Comment
Ready for operation <ul style="list-style-type: none"> Without present setpoint 		Display of 3 static underscores When underscores are flashing slowly: <ul style="list-style-type: none"> Frequency inverter is not ready for operation (e.g.): <ul style="list-style-type: none"> Switch-on inhibit: Function "Safe pulse block" or "Quick stop active" Enable signal present before the frequency inverter is ready for operation.
In operation		Display of the current operating value (e.g. current frequency).
In case of a warning		The actual operating display remains until the background changes to yellow.
In case of fault		Display of a current and active error message. <ul style="list-style-type: none"> Slow flashing of the display indicates that the error is no longer present and the error message can be acknowledged.
Parameterisation		Display parameter number or parameter value Parameter group (e.g.: motor data (P2xx))
		Parameter number (e.g.: Nominal speed (P202))
		Parameter value (e.g.: 1360 min ⁻¹)
		SK TU5-CTR: PASS flashes if password protection is enabled in P004 (SK 5xxP, see BU 0600) The parameter settings are not saved.

3.2.3 Operation

	Keys	Explanation
All Simple(Control)Boxes	 START key	To switch on the frequency inverter. The frequency inverter is now enabled with the set jog frequency (P113). A possibly preset minimum frequency (P104) is supplied as a minimum. Parameters P509 "Interface" and P510 must be set to {0}.
	 STOP key	To switch off the frequency inverter. The output frequency is reduced to the absolute minimum frequency (P505) and the frequency inverter shuts down.
	 Arrow keys	Press the key to increase the frequency. The parameter number or parameter value is increased during parameterisation.
	 Arrow keys	Press the key to reduce the frequency. The parameter number or parameter value is reduced during parameterisation.
	 ENTER key	Press the ENTER key to save a changed parameter value or to switch between parameter number and parameter value. Note: If a changed value is not to be saved, the  key can be used to exit the parameter.
	 OK key	
SK CSX-3x, SK TU3-CTR	LEDs  P1  P2	The LEDs indicate the current operating parameter set in the operating display (P000) and the current parameter set to be parameterised during parameterisation. In this case, the display is binary coded.  1 = P1  1 = P2  1 = P3  1 = P4  2 = P1  2 = P2  2 = P3  2 = P4
	 Reverse rotation key	The motor's direction of rotation changes after pressing this key. "CCW direction of rotation" is indicated by a minus sign. NOTICE: Take care when operating pumps, screw conveyors, fans, etc. → Disabling the key is possible with parameter P540.
SK TU5-CTR	 ESC key	Dual function <ul style="list-style-type: none"> • If a value is not to be saved, the parameter can be exited by pressing the ESC key. • Changes the direction of rotation when the frequency inverter is enabled. The motor's direction of rotation changes after pressing this key. "CCW direction of rotation" is indicated by a minus sign. NOTICE: Take care when operating pumps, screw conveyors, fans, etc. → Disabling the key is possible with parameter P540.

3.2.4 Control with the (Simple)ControlBox SK CSX-3x and SK TU3-CTR

The frequency inverter can only be controlled via the (Simple)ControlBox, if it has not been previously enabled via the control terminals or via a serial interface (**P509 = 0** and **P510 = 0**). If the START key is pressed, the frequency inverter changes to the operating display (selection **P001**). It supplies 0 Hz or the set minimum frequency (**P104**) or jog frequency (**P113**).

The following figure is to be applied analogously for the ControlBox SK TU3-CTR.

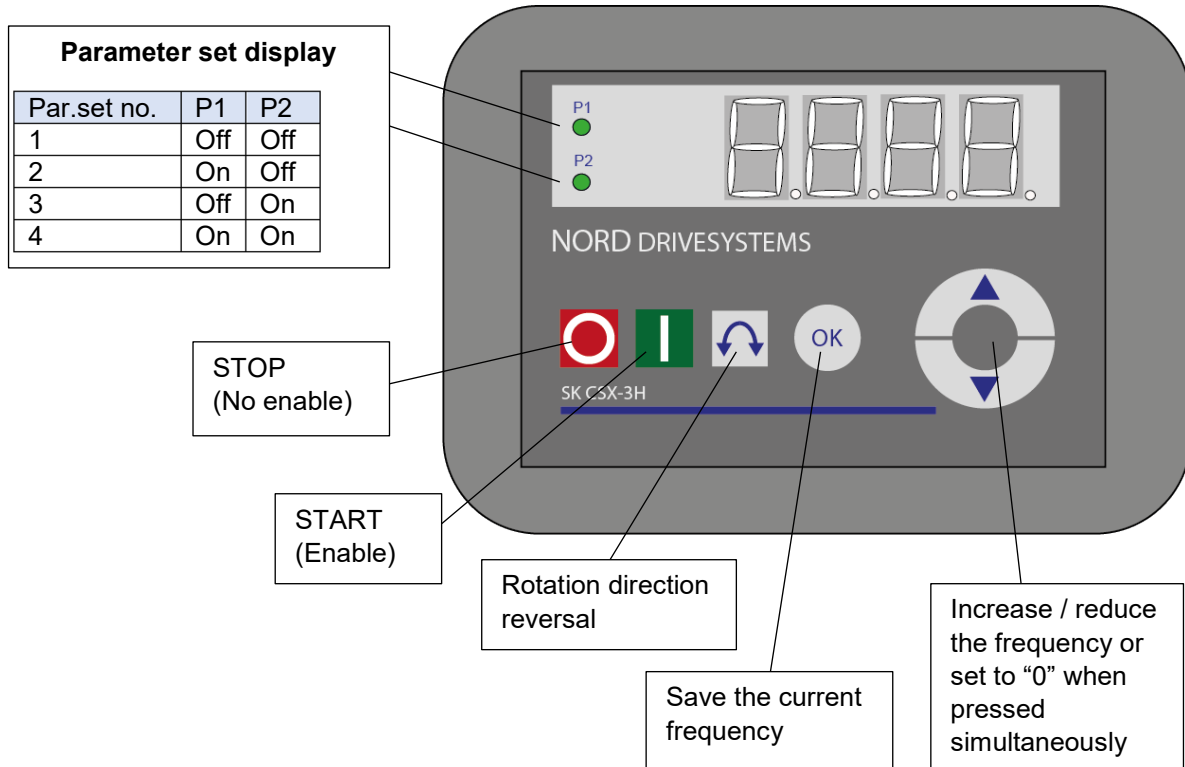

Parameter set display

The LEDs indicate the current operating parameter set in the operating display (**P000**) and the current (\neq **P000**) parameter set to be parameterised during parameterisation. In this case, the display is binary coded.

The parameter set can also be switched (with control via SimpleBox) during operation via parameter **P100**.

Frequency setpoint

The current frequency setpoint depends on the setting in parameters **P113** "Jog frequency" and **P104** "Minimum frequency". During keyboard operation, this value can be changed with the \blacktriangle and \blacktriangledown arrow keys and permanently stored as the jog frequency in **P113** by pressing the ENTER key.

Quick stop

(Only SK TU3-CTR)

A quick stop can be triggered by simultaneously pressing the STOP key and the key for rotation direction reversal.

i Information

Notes on the SimpleControlBox (SK CSX-3x)

When used on frequency inverters of the SK 500E series, no technology unit (SK TU3-PAR) must be plugged in. Otherwise, communication errors are to be expected.

3.2.5 Controlling with the ControlBox SK TU5-CTR

The frequency inverter can only be controlled via the ControlBox, if it has not been previously enabled via the control terminals or via a serial interface (**P509 = 0** and **P510 = 0**).





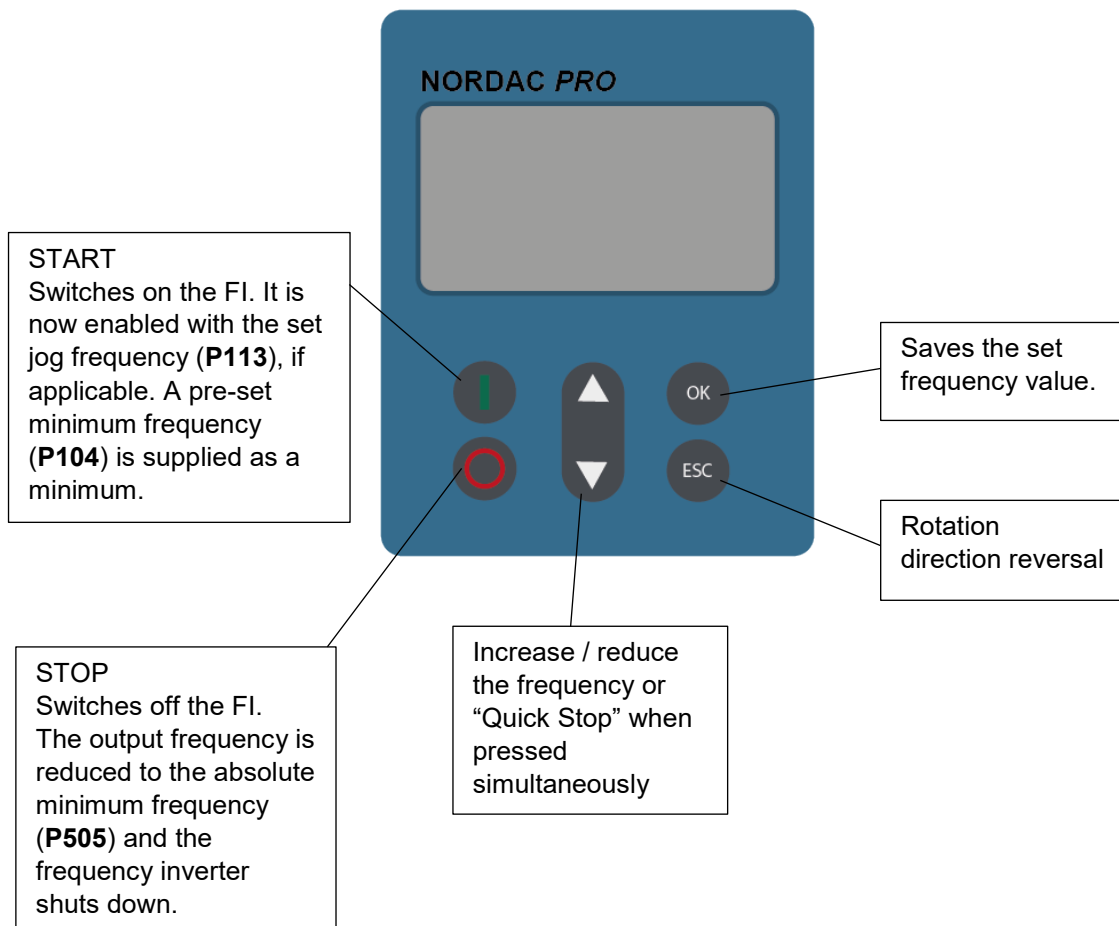

Once the control panel has been mounted on the frequency inverter and provided with power, the display briefly shows the type of device and the rated power. After this, the display for operational readiness is shown.

If the START key is pressed, the frequency inverter changes to the operating display (selection **P001**). It supplies 0 Hz or the set minimum frequency (**P104**) or jog frequency (**P113**).

Further information on the SK 500P and parameterisation can be found in the [BU 0600](#).



Further functions can be accessed via combinations of two or more keys:

 + 	If the inverter is switched on: switchover to the parameter level	
 + 	Trigger quick stop by enabling with the keyboard	
 + 	Reset the value to the default setting	
	Flashing:	Only the last 5 bars flash: Warning, inverter overloaded. Over a long period, this results in a shutdown with an I ² t error or a PT error
	Lights:	Depending on the number of bars which are displayed, the inverter has a load of 0% (0 bars) to ≥ 150% (15 bars).

Parameter set display

The LEDs indicate the current operating parameter set in the operating display (**P000**) and the current (\neq **P000**) parameter set to be parameterised during parameterisation.

For control of the frequency inverter via the control panel, the parameter set can be switched over via **P100** even during operation and will be displayed in the display (P1...P4).

Frequency setpoint

The actual frequency setpoint depends on the setting in the parameters “Jog frequency” (**P113**) and “Minimum frequency” (**P104**). With keyboard operation, this value can be changed with the **▲** and **▼** value keys and permanently saved as the jog frequency in **P113** by pressing the ENTER key.

Emergency stop:

By simultaneously pressing the ESC and STOP keys, a quick stop can be initiated.

Minimum frequency

Switching to the minimum frequency is carried out by pressing the **▼** and **▲** arrow keys simultaneously.

4 Parameterisation

4.1 Parameterisation with the ParameterBox

The parameterisation mode can be accessed by selecting the menu item >Parameterization< in level 1 of the ParameterBox. Pressing the ENTER key accesses the parameter level of the connected frequency inverter.

The following drawings illustrate the function of the control elements of the ParameterBoxes for parameterisation.

SK PAR-3x

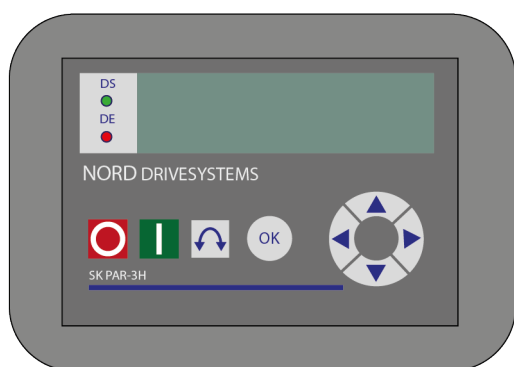

SK TU3-PAR

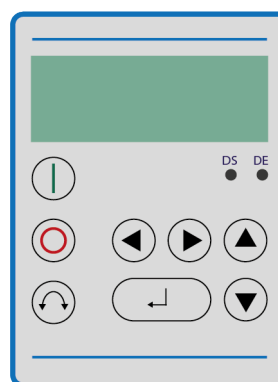









SK PAR-5x



SK TU5-PAR

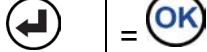

	One menu level forward or save parameter value
	Value +
	Value -
	Load factory setting
	Back
	Forward
	One menu level forward
	= 

Screen layout during parameterisation

If the setting of the parameter is changed, the value flashes until it is confirmed with the ENTER key. To retain the factory settings for the parameter to be edited, the ▲ and ▼ arrow keys must be pressed simultaneously. Even in this case, the setting must be confirmed with the ENTER key to save the change.

If the change is not to be saved, pressing one of the ◀ or ▶ arrow keys will call up the previously saved value and pressing the left or right arrow key again will exit the parameter.

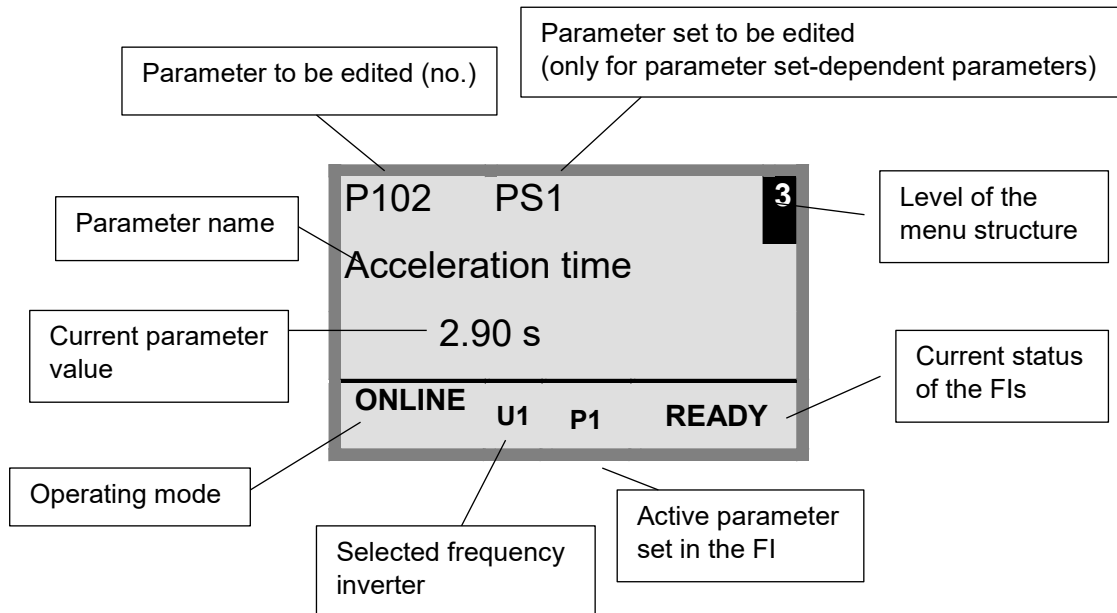

Information

The bottom line in the display is used to display the current status of the ParameterBox and the frequency inverter to be controlled.

Information

Some parameters, e.g.: P465, P475, P480 ... P483, P502, P510, P515, P534, P552, P701 ... P707, P718, P740 / 741 an P748 (depending on the inverter series) have additional levels (arrays), in which further settings can be made. After the parameter has been reached, the required array level must be selected with the ▲ or ▼ arrow keys and confirmed with ENTER.

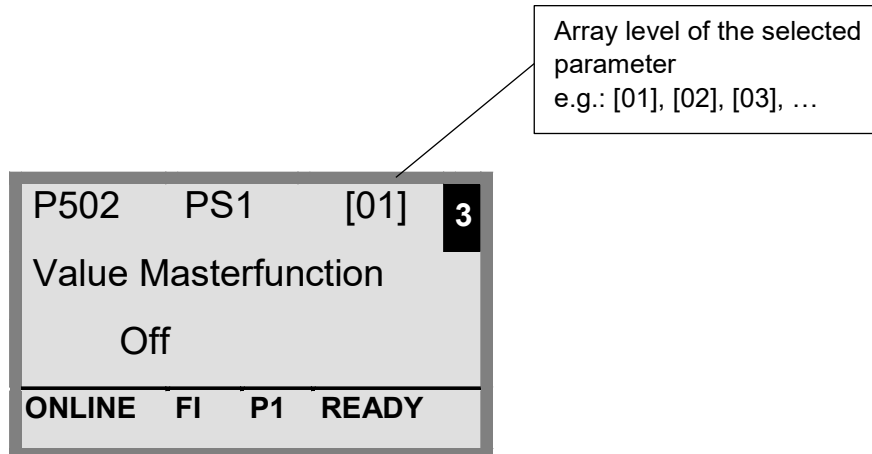

Parameterisation in ControlBox mode

The parameterisation of the frequency inverter in ControlBox mode is carried out in the same way as the parameterisation of the SimpleBox / ControlBox. A detailed description can be found in Chapter 4.2 "Parameterisation with the (Simple)ControlBox".

Menu structure in ControlBox mode

The menu structure in ControlBox mode corresponds to that of the SimpleBox / ControlBox. A detailed description can be found in Chapter 4.2.3 "Menu structure of the (Simple)ControlBox".

PLC visualisation mode

From firmware version V4.3 (parameter (**P1308**)), the ParameterBox is equipped with the "PLC display" visualisation mode. This mode is activated in parameter **P1003**.

In this mode, communication of the ParameterBox with the PLC (SPS) of a suitably equipped frequency inverter from NORD DRIVESYSTEMS (e.g. SK 540E / SK 545E) is possible so that the PLC can use the entire display as a display interface.

Further information regarding the PLC is described in the BU0550 manual.

4.1.1 Data transfer with NORDCON

(except SK TU3-PAR)

The storage elements S1 to S5 of the ParameterBox can be managed using the NORDCON control and parameterisation software.

To transfer data between the PC and SK PAR-3H, only a standard USB device connection cable (USB 2.0 connection cable plug series A to plug series B) is required. The power supply of the box is also via this connection.

To transfer data between the PC and SK PAR-5H / -5A or SK TU5-PAR, only a standard USB device connection cable (USB-C) is required. The power supply of the box is also via this connection.

The necessary driver software for the USB interface on the PC is supplied with the enclosed "EPD" CD (in the Disk13 folder of the NORDCON installation file) but is also available free of charge on our internet page (www.nord.com).







Make sure that the USB port is suitable for *HighPower* devices. A USB 2.0 interface on the PC is required.

NOTICE

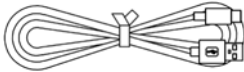
Damage to the PC

The SK PAR-3H/-5H/-5A and SK TU5-PAR ParameterBox must never be connected to a device and to the PC at the same time, as this may result in damage, in particular to the PC.

The following components are necessary for the connection ParameterBox → PC / laptop:

			
<p>ParameterBox SK PAR-3H Part no.: 275281014</p>	<p>USB 2.0 connection cable plug series A to plug series B for SK PAR-3H → PC</p>	<p>PC / laptop</p>	<p>NORDCON software www.nord.com</p>
			
<p>ParameterBox SK PAR-5H/-5A, SK TU5-PAR Part no.: 275281614</p>	<p>USB-C connection cable (USB type C) for SK PAR-5H/-5A and SK TU5-PAR → PC</p>	<p>PC / laptop</p>	<p>NORDCON software www.nord.com</p>

Communication is controlled by the PC / laptop in this configuration. In the menu item “Options” → Parameter “Operating mode (**P1302**)”, the ParameterBox must be set to the value “PC-Slave” (SK PAR-3H: automatic switchover). After a bus scan, the NORDCON program will then detect the filed storage objects S1 to S5 as separate frequency inverters with bus addresses 1 to 5 and display them on the screen.

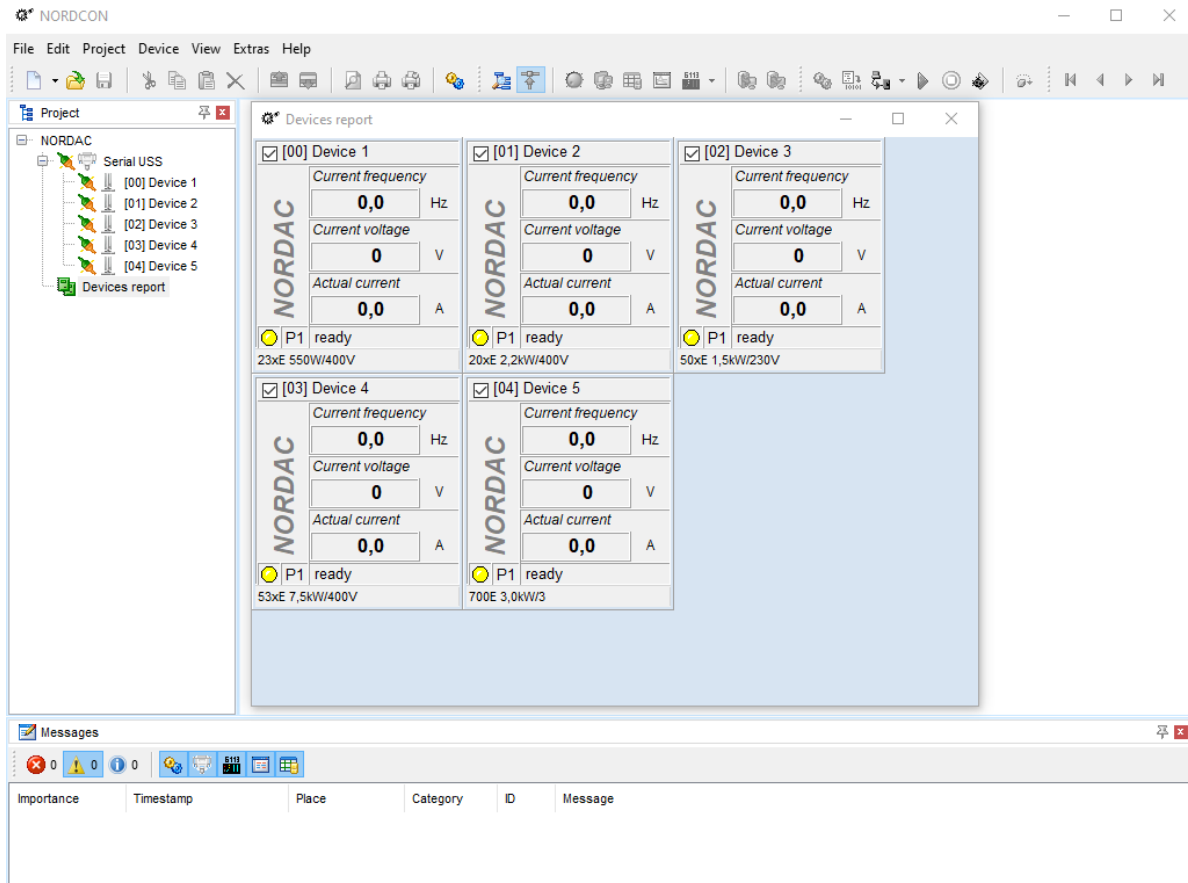

Figure 6: NORDCON display: Bus scan

All NORDCON parameterisation functions are now available.

Information

Pre-assembly of a frequency inverter data set

Only storage objects saved in the frequency inverter (data sets) can be detected and processed by the NORDCON parameterisation software. To edit the data set for a new frequency inverter (i.e. a new data set is to be created), the frequency inverter type must first be set via the parameter **P1204** “Load default values” in the ParameterBox.

By means of a new bus scan on the NORDCON level, the software identifies the new storage object, which can then be edited with the usual tools.

4.2 Parameterisation with the (Simple)ControlBox

4.2.1 Parameterisation with the SK TU3-CTR, SK CSX-3H/E

The parameterisation of the frequency inverter can be carried out in the various operating statuses. All parameters can always be changed online. The switchover to parameter mode is performed in different ways depending upon the operating status and the enabling source.

1. If there is no enable via the box, the control terminals or a serial interface (press STOP key if necessary), it is possible to directly switch from the operating value display to the parameterisation mode using the ▼ or ▲ arrow keys → **P0_ / P7_**
2. If an enable is present via the control terminals or a serial interface and the frequency inverter delivers an output frequency, it is also possible to directly switch from the operating value display to the parameterisation mode using the ▼ or ▲ arrow keys → **P0_ / P7_**
3. If the frequency inverter was enabled via the box (START key), the parameterisation mode can be accessed by pressing the START and ENTER keys simultaneously.
4. Switching back to control mode is done by pressing the START key.

The following figure must be applied for the SimpleBox and analogously for the ControlBox.

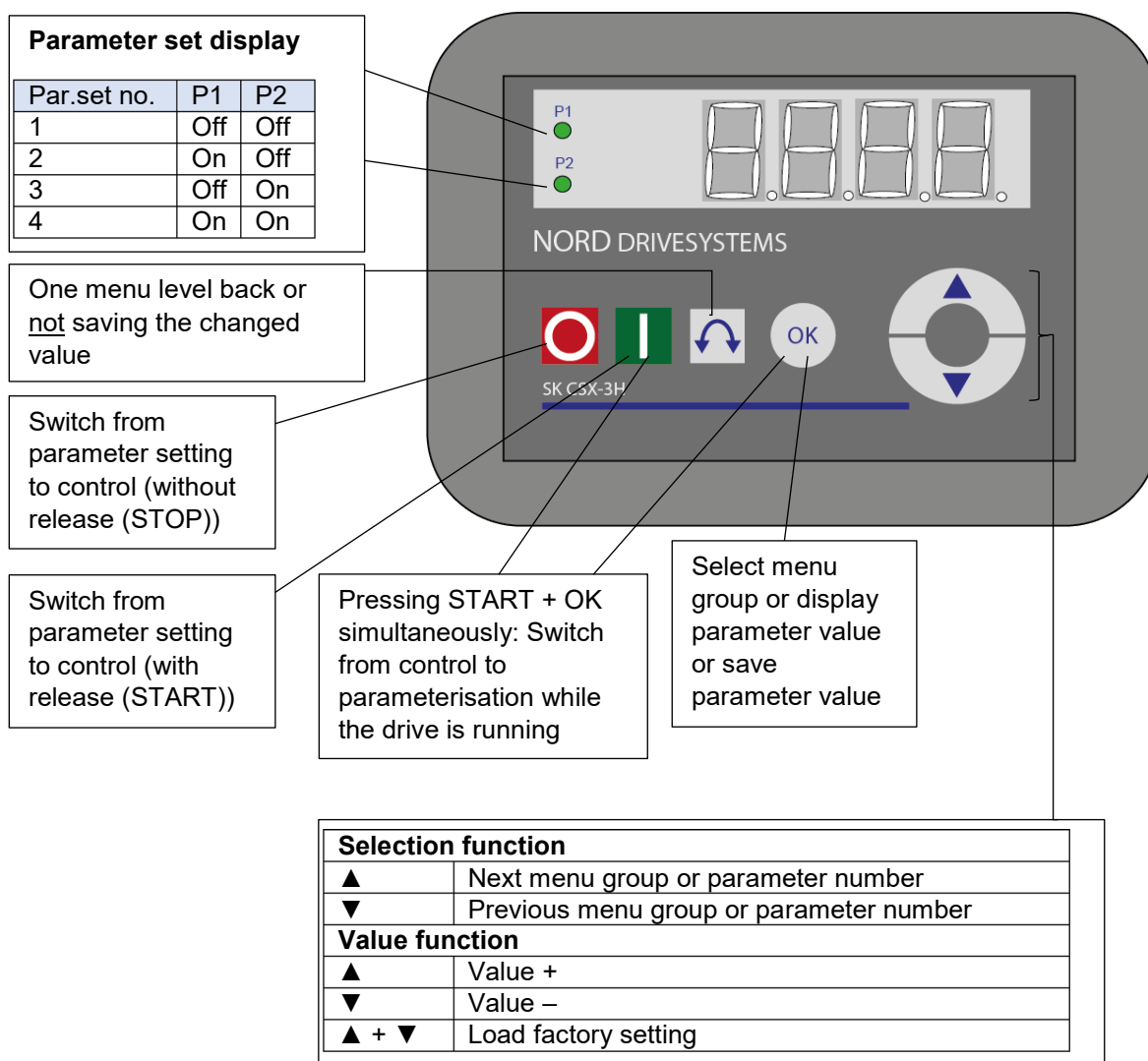

Changing parameter values

To access the parameter range, press one of the ▼ or ▲ arrow keys. The display changes to the menu group display **P 0 _** ... **P 7 _ _**. After pressing the ENTER key, the menu group is accessed and the desired parameter can be selected with the ▼ and ▲ arrow keys. All parameters are arranged in sequence in a ring structure in the individual menu groups. It is therefore possible to scroll forwards or backwards within this section. Each parameter has a parameter number. → **P x x x.**

4.2.2 Parameterisation with the SK TU5-CTR

The switchover to parameter mode is performed in different ways depending upon the operating states and the enabling source.

1. If enabling is not present via the control panel, control terminals or a serial interface, switchover from the operating value display to parameterisation mode can be made directly with ▼ or ▲.
2. If an enable is present via the control terminals or a serial interface and the frequency inverter is producing an output frequency, it is also possible to switch to the parameterisation mode directly from the operating value display using the ▼ or ▲ keys.
3. If the frequency inverter has been enabled via the control panel (START key), the parameterisation mode can be reactivated with the key combination START and OK. Exit is only possible by using the START key. The STOP key retains its function

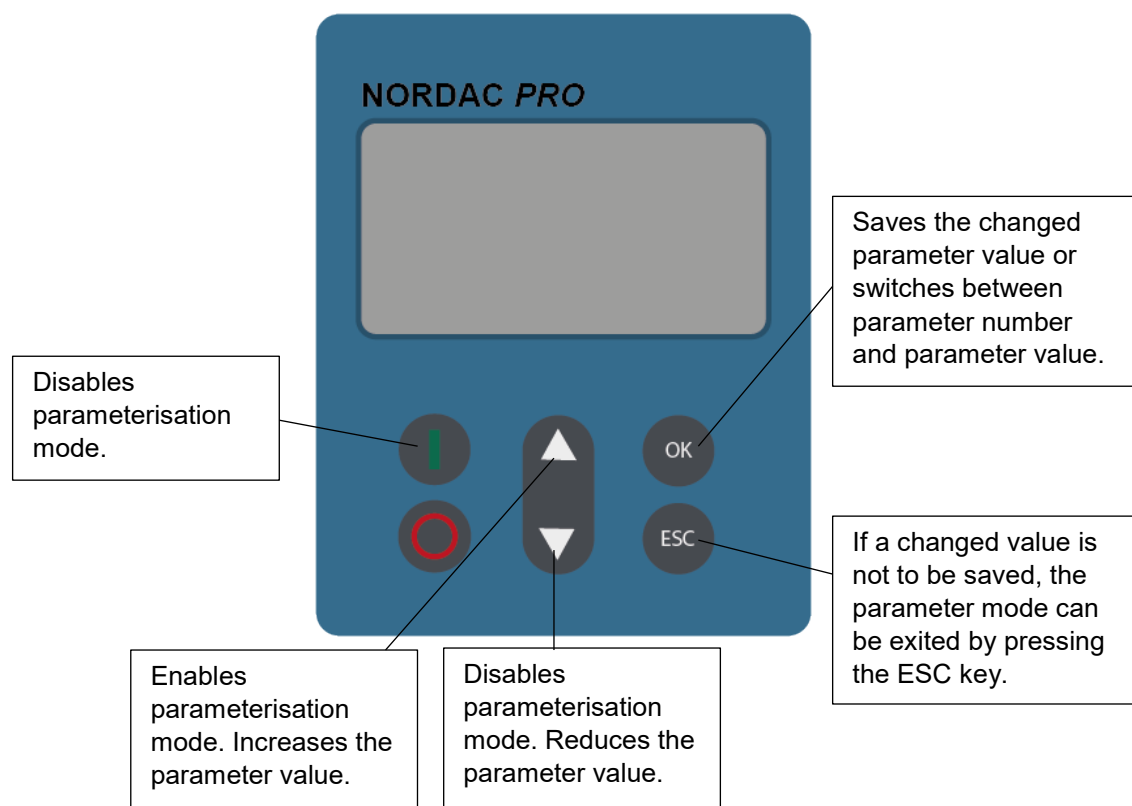

Changing parameter values

Each parameter has a parameter number → P x x x

1. Press ▼ or ▲, to access the parameter area. The display changes to the menu group display P 0 __ ... P 8 __.
2. Press the START key to open the menu group. All parameters are arranged in a ring structure in the individual menu groups. It is therefore possible to scroll forwards or backwards within this section.
3. Select the required parameter with ▼ or ▲ and press the OK key.
4. Change the setting with ▼ or ▲ and confirm the changed setting by pressing the OK key.
5. Optionally, the parameter can be reset to its default value by pressing the ▼ and ▲ keys simultaneously.

As long as a changed value has not been confirmed by pressing the OK key, the value display will flash; this value is not stored in the frequency inverter. Changed values, which have not been saved, flash. Flashing only stops when these have been saved (by pressing the OK key).

Press the ESC key to exit from the menu.

4.2.3 Menu structure of the (Simple)ControlBox

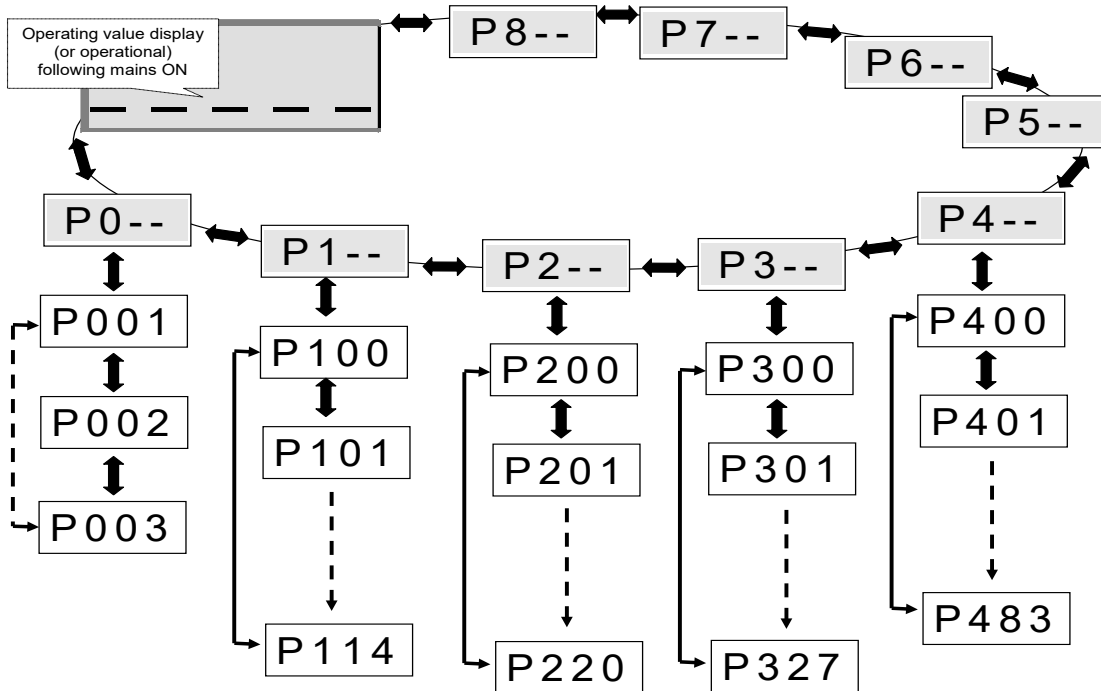

i Information

Some parameters, e.g.: P465, P475, P480 ... P483, P502, P510, P515, P534, P552, P701 ... P707, P718, P740 / 741 and P748 (depending on the inverter series) have additional levels (arrays), in which further settings can be made.

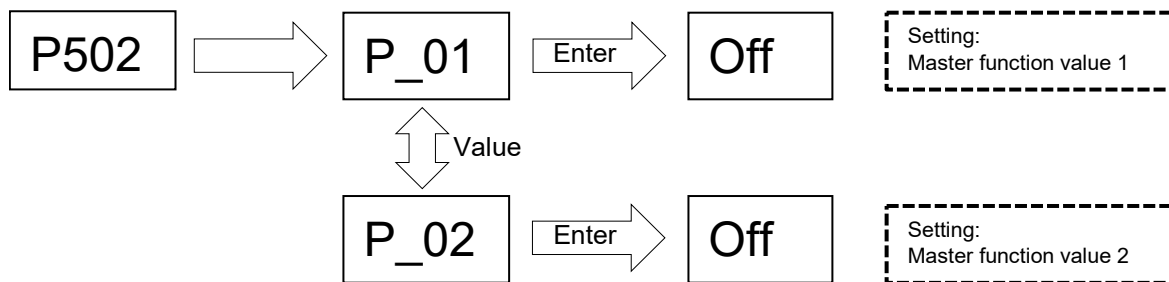

To change a parameter value, the ENTER key must be pressed when the corresponding parameter number is displayed.

Changes can be made with the ▼ or ▲ arrow keys and must be confirmed with the ENTER key to save and exit the parameter.

As long as a changed value has not been confirmed with ENTER, the value display flashes; the value has then not yet been saved in the frequency inverter. If a change shall not be saved, the reverse rotation key can be used to exit the parameter.

5 Parameter

The menu structure of the ParameterBox is described in Chapter 3.1.3 "Controlling the frequency inverter".

The following master functions are assigned to the menu groups:

Menu group	No.	Master function
Display	(P10--)	Selection of the operating values and display layout
Parameterization	(P11--)	Programming of all connected frequency inverters and storage objects
Param. management	(P12--)	Copying and saving complete parameter sets from storage objects and frequency inverters
Options	(P13--)	Setting the ParameterBox functions and all automatic processes

Information

Factory setting P1307

The ParameterBox can be reset to its factory settings at any time using parameter **P1307**. For example, this can be helpful during commissioning if it is not known which ParameterBox parameters were changed at an earlier time.

All settings of the ParameterBox and data in the storage objects are deleted with parameter **P1307**.

It is advisable to back up the present settings of the frequency inverter beforehand.

P000 (parameter number)	Operating para. disp. (parameter name)	S	P
Setting range or display range	Display of typical display format (e.g. (bin = binary)) of possible setting range and number of decimal places		
Arrays	[-01] If parameters have a substructure in several arrays, this is shown here.		
Factory setting	{ 0 } Typical default setting of parameters in the as-delivered condition of the FI, or to which it is set after carrying out "Restore factory settings" (see parameter P523).		
Scope of application	List of variants for which this parameter applies. If the parameter is generally valid, i.e. for the entire model series, this line is omitted.		
Description	Description, function, meaning and similar for this parameter.		
Note	Additional notes about this parameter		
Setting values or display values	List of possible settings with description of their respective functions		

Figure 7: Explanation of parameter description

Information

Parameter description

Unused lines of information are not listed.

Information

Software version numbers

If the software version of the parameterisation unit is not up to date (see table), there may be deviations within the parameters. Ensure that the software version is kept as up-to-date as possible.

Software version numbers

Parameterisation unit	Software version numbers
SK PAR-3H	V 4.8 R3
SK PAR-3E	
SK TU3-PAR	
SK CSX-3E	V 1.2
SK CSX-3H	
SK TU3-CTR	V 1.0
SK TU5-CTR	V 1.1
SK TU5-PAR	V 5.0
SK PAR-5H	
SK PAR-5A	

5.1 Parameter overview

Display

P1001 Bus-Scan	P1002 Inverter select	P1003 Display-Mode
P1004 Values to display	P1005 Scaling factor	

Parameterization

P1101 Object selection

Param. management

P1201 Copy - Source	P1202 Copy - Destination	P1203 Copy - Start
P1204 Load default values	P1205 Clear memory	

Options

P1301 Language	P1302 Operating mode	P1303 Auto-Bus-Scan
P1304 Contrast	P1305 Set password	P1306 Box password
P1307 Reset Boxparameter	P1308 NORDAC p-box	

5.1.1 Display

P1001	Bus-Scan	
Setting range	0 ... 1	
Factory setting	{ 0 }	
Description	<p>A bus scan is started with this parameter. During the process, a progress indicator appears in the display.</p> <p>After a bus scan, the display switches to the main menu. The parameter P1001 is reset to "Off".</p> <p>Depending on the result of this process, the ParameterBox switches to the operating mode "ONLINE" or "OFFLINE".</p>	
Setting values	Value	Meaning
	0	Off
	1	Start

P1002	Inverter select	
Setting range	0 ... 4	
Factory setting	{ 0 }	
Description	<p>Selection of the current object for parameterisation / control.</p> <p>The display and operating actions in the further procedure refer to the selected object. Only the devices detected during the bus scan are available in the selection list of frequency inverters. The current object appears in the status line.</p>	
Note	If an error has occurred for a connected frequency inverter, it can be acknowledged by selecting the frequency inverter.	
Setting values	Value	Meaning
	0	U1 Frequency inverter 1
	1	U2 Frequency inverter 2
	2	U3 Frequency inverter 3
	3	U4 Frequency inverter 4
	4	U5 Frequency inverter 5

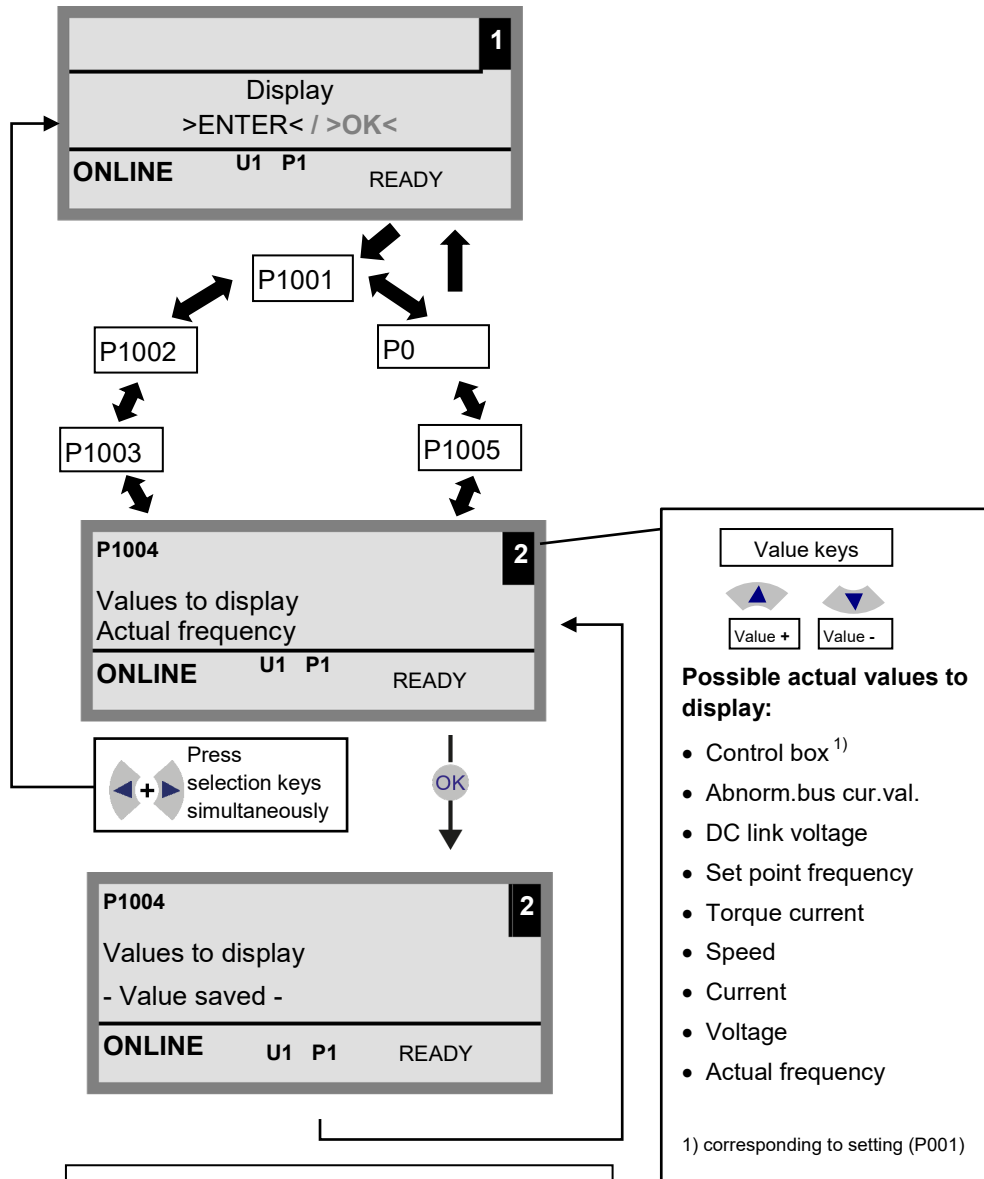

P1003	Display-Mode	
Setting range	0 ... 4	
Factory setting	{ 0 }	
Description	Selection of the operating value display of the ParameterBox	
Setting values	Value	Meaning
	0	Standard Any 3 values next to each other
	1	Large size Any 3 values with unit below each other
	2	List Any 1 value with unit
	3	Control box Any 1 value without unit
	4	PLC display Display mode for PLC functionality (version 4.3 and higher)

Parameterisation example P1004



Example: The following input sequence results in the operating display shown below:

Input sequence:

Current  → Voltage  → Actual frequency 

530E 370W/230V 1		
Fi/Hz	U/V	I/A
45.0	360	3.4
ONLINE	U1 P1	R RUN

P1004	Values to display		
Setting range	0 ... 8		
Factory setting	{ 0 }		
Description	<p>Selection of a display value for the actual value display of the ParameterBox. The selected value is set to the first position of an internal list for display values and is therefore also used in the display mode "<i>Large size</i>".</p> <p>Depending on the setting in parameter P1003, up to 3 operating display values can be selected. The selection is made one after the other, with the last selected value being pushed into the display from the left or top.</p>		
Setting values	Value	Meaning	
	0	Actual frequency	
	1	Voltage	
	2	Current	
	3	Speed	
	4	Torque current	
	5	Set point frequency	
	6	DC link voltage	<i>DC link voltage</i>
	7	Abnorm.bus cur.val.1	<i>Abnormal bus actual value</i>
	8	Control box	
P1005	Scaling factor		
Setting range	-327.67 ... +327.67		
Arrays	{ 1.00 }		
Description	The first value of the display list is scaled with the scaling factor. If this scaling factor deviates from {1.00}, the unit of the scaled value is hidden in the display.		

5.1.2 Parameterisation

P1101	Object selection	
Setting range	0 ... 9	
Factory setting	{ ... }	
Description	<p>Selection of the object to be parameterised.</p> <p>The parameterisation in the further procedure refers to the selected object. Only the devices detected during the bus scan and the storage objects are available in the displayed selection list.</p>	
Note	This parameter is hidden if only one device is detected and no storage is present.	
Setting values	Value	Meaning
	0	S1: Storage object 1
	1	S2: Storage object 2
	2	S3: Storage object 3
	3	S4: Storage object 4
	4	S5: Storage object 5
	5	U1: Frequency inverter 1
	6	U2: Frequency inverter 2
	7	U3: Frequency inverter 3
	8	U4: Frequency inverter 4
	9	U5: Frequency inverter 5

5.1.3 Param. management

P1201		Copy - Source	
Setting range	0 ... 9		
Factory setting	{ ... }		
Description	Selection of the current source object for copying. Only the inverters detected during the bus scan and the storage objects are available in the selection list.		
Setting values	Value	Meaning	
	0	S1:	Storage object 1
	1	S2:	Storage object 2
	2	S3:	Storage object 3
	3	S4:	Storage object 4
	4	S5:	Storage object 5
	5	U1:	Frequency inverter 1
	6	U2:	Frequency inverter 2
	7	U3:	Frequency inverter 3
	8	U4:	Frequency inverter 4
	9	U5:	Frequency inverter 5

P1202		Copy - Destination	
Setting range	0 ... 9		
Factory setting	{ ... }		
Description	Selection of the current target object for copying. Only the inverters detected during the bus scan and the storage objects are available in the selection list.		
Setting values	Value	Meaning	
	0	S1:	Storage object 1
	1	S2:	Storage object 2
	2	S3:	Storage object 3
	3	S4:	Storage object 4
	4	S5:	Storage object 5
	5	U1:	Frequency inverter 1
	6	U2:	Frequency inverter 2
	7	U3:	Frequency inverter 3
	8	U4:	Frequency inverter 4
	9	U5:	Frequency inverter 5

P1203		Copy - Start	
Setting range	0 ... 1		
Factory setting	{ 0 }		
Description	This parameter initiates a procedure where all parameters of an object selected in P1201 "Copy - Source" are transferred to an object specified in P1202 "Copy - Destination". If it is possible to overwrite data (e.g. when transferring data from a memory location to a connected inverter), a message window with acknowledgement appears. The transfer starts upon confirmation.		
Setting values	Value	Meaning	
	0	Off	
	1	Start	

P1204		Load default values	
Setting range	0 ... 9		
Factory settings	{ ... }		
Description	This parameter describes the parameters of the selected object with default values.		
Note	This function is particularly important for editing the storage objects. Fictitious inverters can only be loaded and edited with the ParameterBox by means of this parameter (see chapter 4.1.1 "Data transfer with NORDCON" on page 50).		
Setting values	Value		Meaning
	0	S1:	Storage object 1
	1	S2:	Storage object 2
	2	S3:	Storage object 3
	3	S4:	Storage object 4
	4	S5:	Storage object 5
	5	U1:	Frequency inverter 1
	6	U2:	Frequency inverter 2
	7	U3:	Frequency inverter 3
	8	U4:	Frequency inverter 4
	9	U5:	Frequency inverter 5
P1205		Clear memory	
Setting range	0 ... 4		
Factory settings	{ 0 }		
Description	This parameter is used to delete the data of the selected storage object.		
Setting values	Value		Meaning
	0	S1:	Storage object 1
	1	S2:	Storage object 2
	2	S3:	Storage object 3
	3	S4:	Storage object 4
	4	S5:	Storage object 5

5.1.4 Options

P1301		Language	
Setting range	0 ... 11		
Factory setting	{ ... }		
Description	Language selection for operation of the ParameterBox.		
Setting values	Value		Meaning
	0	Deutsch	<i>German</i>
	1	English	<i>English</i>
	2	Français	<i>French</i>
	3	Español	<i>Spanish</i>
	4	Svenska	<i>Swedish</i>
	5	Nederlands	<i>Dutch</i>
	6	Polski	<i>Polish</i>
	7	Italiano	<i>Italian</i>
	8	Czech	<i>Czech</i>
	9	Suomeksi	<i>Finnish</i>
	10	Dansk	<i>Danish</i>
	11	Russian	<i>Russian</i>

P1302		Operating mode	
Setting range	0 ... 4		
Factory settings	{ 1 }		
Description	Selection of the operating mode of the NORD ParameterBox.		
Note	If no storage object is saved, no object can be found by NORDCON.		
Setting values	Value		Meaning
	0	Offline	The ParameterBox is operated autonomously. No PC or frequency inverter is connected. The storage object can be parameterised or managed.
	1	Online	One or more frequency inverters are located at the interface of the ParameterBox. The frequency inverters can be parameterised or controlled. A bus scan starts automatically when switching to the "Online" operating mode.
	2	PC-Slave	A PC is located at the interface of the ParameterBox. The ParameterBox can be addressed as a slave via the NORDCON parameterisation software. The storage objects report as separate frequency inverters. S1 → USS address 1 S2 → USS address 2 S3 → USS address 3 S4 → USS address 4 S5 → USS address 5
	3	Reserved 1	
	4	Reserved 2	

P1303	Auto-Bus-Scan		
Setting range	0 ... 1		
Factory setting	{ 1 }		
Description	Setting the switch-on behaviour.		
Setting values	Value	Meaning	
	0	Off	No bus scan is carried out. The frequency inverters connected before switching off are searched for when switching on again.
	1	On	A bus scan is carried out automatically when switching on the ParameterBox.
P1304	Contrast		
Setting range	0 ... 100 %		
Factory settings	{ 50 }		
Description	Contrast settings for the display of the ParameterBox.		
P1305	Set password		
Setting range	0 ... 9999		
Factory settings	{ 0 }		
Description	This parameter can be used to assign a password.		
Note	If a value other than 0 is entered in this parameter, the settings of the ParameterBox or the parameters of the connected frequency inverters cannot be changed.		
P1306	Box password		
Setting range	0 ... 9999		
Factory settings	{ 0 }		
Description	If the "Password" function is to be reset, the password chosen in parameter P1305 "Set password" must be set here. If the correct password has been chosen, all functions of the ParameterBox can be used again.		
Note	In case the password is not known but the frequency inverter's parameterisation must still be accessed, please contact our technical support.		
P1307	Reset Boxparameter		
Setting range	0 ... 1		
Factory setting	{ 0 }		
Description	With this parameter, the ParameterBox can be reset to the factory settings. All settings of the ParameterBox and the data in the storage objects will be deleted.		
Setting values	Value	Meaning	
	0	Off	
	1	Start	
P1308	NORDAC p-box		
Setting range	Version ... R ...		
Factory setting	{ ... }		
Description	Displays the software version of the ParameterBox, please have ready if required.		

6 Error an warning messages

6.1 Error messages (ControlBox (SK TU5-CTR))

All possible error messages of the ControlBox (SK TU5-CTR) will be described in the following.

Communication error

Error code display	Fault	Cause
9.1 – 9.9	Communication error with the frequency inverter	<ul style="list-style-type: none"> Remedy <p>These error messages are based on EMC interferences.</p> <ul style="list-style-type: none"> Check the wiring of all components regarding possible EMC interferences

6.2 Error messages (ParameterBox)

All possible error messages of the ParameterBox will be described in the following. Error messages concerning the connected frequency inverter (E xx.x) are described in the respective frequency inverter manual or in the corresponding supplementary manual.

Communication error

Error code display	Fault Text in the ParameterBox	Cause
200	Parameter number inadmissible	<ul style="list-style-type: none"> Remedy <p>These error messages are based on EMC interferences or different software versions of the participants.</p> <ul style="list-style-type: none"> Check the software versions of the ParameterBox and the connected frequency inverter Check the wiring of all components regarding possible EMC interferences Pluggable EEPROM on the frequency inverter (memory module) could not be recognised (error 201) → Check if it is correctly seated
201	Parameter value cannot be changed	
202	Parameter value outside the value range	
203	Error in SUB index	
204	No array parameter	
205	Wrong parameter type	
206	Invalid answer code USS interface	
207	Checksum error USS interface	<p>The communication between the frequency inverter and ParameterBox is disturbed (EMC). Safe operation cannot be guaranteed.</p> <ul style="list-style-type: none"> Check the connection to the frequency inverter. Use a shielded connection between the devices. Install the bus cable separately from the motor cables.
208	Invalid state code USS interface	
209	Timeout error	<p>The ParameterBox expects a response from the connected frequency inverter. The waiting time has expired without a response being received.</p> <ul style="list-style-type: none"> Check the connection to the frequency inverter. The setting of the USS parameters of the frequency inverter were changed during operation.

Identification error

Error code display	Fault Text in the ParameterBox	Cause • Remedy
220	Unknown device	Device ID was not found. The connected frequency inverter is not listed in the ParameterBox database, communication cannot be established. • Please contact the Getriebebau NORD GmbH & Co KG support.
221	Unknown version of software	Software version was not found. The software of the connected frequency inverter is not listed in the ParameterBox database → communication cannot be established. • Please contact the Getriebebau NORD GmbH & Co KG support.
222	Unknown version of extension	There is an unknown module (customer unit / special extension) in the frequency inverter. • Check the modules installed in the frequency inverter. • If necessary, check the software version of the ParameterBox and frequency inverter
223	New bus configuration	When restoring the last bus configuration, a device other than the saved one reports. This error can only occur if the parameter P1303 "Auto-Bus-Scan" is set to "Off" and a different device has been connected to the ParameterBox. • Activate the Auto-Bus-Scan function.
224	Device is not supported	The frequency inverter type used at the ParameterBox is not supported. The ParameterBox cannot be used with this frequency inverter.
225	The connection is disabled	Access to a device that is not online (previous timeout error). • Carry out a bus scan via parameter P1001 "Bus-Scan".

Error during ParameterBox operation

Error code display	Fault Text in the ParameterBox	Cause • Remedy
226	Source and destination are different devices	Copying objects of different types (from / to different inverters) is not possible.
227	Source has no data	Copying data from a deleted (empty) storage object
228	This combination is not allowed	The destination and source for the copy function are identical. The command cannot be carried out.
229	The selected object is cleared	Parameterisation attempt of a deleted storage object
230	Different SW version	Notice! Copying objects with different software versions. Problems may occur when transferring the parameters!
231	Invalid password	Attempt to change a parameter without entering a valid box password in parameter P1306 "Box password".
232	Bus scan only with operating mode online	A bus scan (search for a connected frequency inverter) is only possible during online operation.

Error during frequency inverter control

Error code display	Fault Text in the ParameterBox	Cause • Remedy
250	This function is not enabled	The requested function is not enabled in the frequency inverter parameter "Interface": • Change the value of the parameter "Interface" of the connected frequency inverter to the required function. Note: Further information can be found in the manual of the respective frequency inverter.
251	Control command was not successful	The control command could not be implemented by the frequency inverter, as a higher-level function, e.g. "Quick stop" or an Off signal, is present at the control terminals of the frequency inverter.
252	No control in offline mode	Calling up a control function in offline mode. • Change the operating mode of the p-box in parameter P1302 "Operating mode" to "Online" and repeat the previous action.
253	Error acknowledgement not successful	The acknowledgement of an error on the frequency inverter was not successful. The error message remains in effect.

Error message from the frequency inverter

Error code display	Fault Text in the ParameterBox	Cause • Remedy
FI error code	FI error text	An error with the code displayed has occurred in the frequency inverter. The error code and error text of the frequency inverter are displayed.

6.3 Warnings (ParameterBox)

Error code display	Fault Text in the ParameterBox	Cause • Remedy
240	Overwrite existing data? ⇒ Yes No	This warning indicates a possibly serious change that needs additional confirmation. After selecting the further procedure, confirm with "ENTER".
241	Delete existing data? ⇒ Yes No	
242	Different SW version? ⇒ Continue Cancel	
243	Different series? ⇒ Continue Cancel	
244	Delete existing data? ⇒ Yes No	







7 Technical data





Designation	Unit	SK PAR-3H	SK PAR-3E	SK CSX-3H	SK CSX-3E	SK PAR-5H	SK PAR-5A
Supply voltage	V _{DC}	4.5 ... 30					
Power consumption approx.	W	1.3	1.3	1.0	1.0	0.7	0.7
Ambient temperature	°C	0 ... 40				-20 ... 50	-20 ... 40
Protection class		IP54 2)	IP54 3)	IP54 2)	IP54 3)	IP44	IP54 1)
Dimensions (L x W x D)	mm	117 x 73 x 24	128 x 83 x 32	117 x 73 x 24	128 x 83 x 32	76.6 x 76.6 x 22.8	76.6 x 76.6 x 22.8
Weight approx.	kg	0.2	0.6	0.2	0.6	0.1	0.1
Length connection cable approx.	m	2		2		1.5	
Designation	Unit	SK TU3-CTR	SK TU5-CTR	SK TU3-PAR	SK TU5-PAR		
Supply voltage	V _{DC}	4.5 ... 30					
Power consumption approx.	W	1.0	0.5	1.3	0.5		
Ambient temperature	°C	0 ... 40			-20 ... 40		
Protection class		IP20	IP20	IP20	IP20		
Dimensions (L x W x D)	mm	73 x 100 x 20	72.5 x 65 x 16	73 x 100 x 20	72.5 x 65 x 16		
Weight approx.	kg	0.2	0.05	0.2	0.05		
Length connection cable approx.	m	Not possible	Not possible	Not possible	Not possible		

- 1) Only in vertical installation position
- 2) On the IP20 socket
- 3) Front side

8 Additional information

8.1 Assignment parameterisation unit - frequency inverter

Frequency inverter / interface		Parameterisation units									
		SK PAR-3H	SK CSX-3H	SK PAR-5H	SK PAR-5A	SK PAR-3E	SK CSX-3E	SK TU3-PAR	SK TU3-CTR	SK-TU5-PAR	SK TU5-CTR
SK 135E	 NORDAC START	✓ 1)	✓ 1)	✓ 1)	x	x	x	x	x	x	x
SK 155E-FDS	 NORDAC LINK	✓	✓	✓	x	x	x	x	x	x	x
SK 180E	 NORDAC BASE	✓	✓	✓	✓	x	x	x	x	x	x
SK 200E	 NORDAC FLEX	✓	✓	✓	✓	x	x	x	x	x	x
SK 250E-FDS	 NORDAC LINK	✓	✓	✓	x	x	x	x	x	x	x
SK 300P	 NORDAC ON	✓	✓	✓	x	x	x	x	x	x	x

Frequency inverter / interface		Parameterisation units									
		SK PAR-3H	SK CSX-3H	SK PAR-5H	SK PAR-5A	SK PAR-3E	SK CSX-3E	SK TU3-PAR	SK TU3-CTR	SK-TU5-PAR	SK TU5-CTR
SK 500P	 NORDAC PRO	✓	✓	✓	x	✓	✓	x	x	✓ ²⁾	✓
SK 500E	 NORDAC PRO	✓	✓	✓	x	✓	✓	✓	✓	x	x
SK T14-TU-BUS	 adapter unit	✓	✓	✓	✓	✓	✓	x	x	x	x
NORDCON	 Parameterisation software	✓ ³⁾	✓ ³⁾	✓ ⁴⁾	✓ ⁴⁾	x	x	x	x	x	x

1) Only in conjunction with signal converter SK TIE4-RS485-RS232 (material number 275274603)

2) Frequency inverter: firmware version 1.4R0 and higher









3) A standard USB cable (USB 2.0 plug series A to plug series B) is required for the connection with NORDCON.

4) A standard USB-C cable (USB type C plug series A to plug series B) is required for the connection with NORDCON.

8.2 Further documentation and software

Documents and software can be downloaded from our website www.nord.com.



Other applicable documents and further information

Documentation	Description
 BU 0000	Manual for use of NORDCON software
 BU 0135	Manual for motor starters NORDAC <i>START</i> (SK 135E)
 BU 0155	Manual for motor starters NORDAC <i>LINK</i> (SK 155E-FDS)
 BU 0180	Manual for frequency inverter NORDAC <i>BASE</i> (SK 180E)
 BU 0200	Manual for frequency inverter NORDAC <i>FLEX</i> (SK 200E)
 BU 0250	Manual for frequency inverter NORDAC <i>LINK</i> (SK 250E-FDS)
 BU 0500	Manual for frequency inverter NORDAC <i>PRO</i> (SK 500E)
 BU 0600	Manual for frequency inverter NORDAC <i>PRO</i> (SK 500P)
 BU 0800	Manual for frequency inverter NORDAC <i>ON</i> (SK 300P)

Software

Software	Description
NORDCON	Parameterisation and diagnostic software

Technical data sheets

Documentation	Description
 TI 278910120	SK POT1-1 control box / manual control unit
 TI 278910140	SK POT1-2 control box / manual control unit
 TI 275271513	SK SSX-3A control box / manual control unit

9 Maintenance and service notes

9.1 Maintenance information

The parameterisation units are *maintenance-free* in normal operation (see chapter 7 "Technical data" on page 70).

9.2 Service notes

For service/repair cases please contact your NORD Service contact person. You will find your contact person listed on your order confirmation. Additionally you will find further possible contact persons using the following link: <https://www.nord.com/en/global/locatortool.jsp>.

When contacting our technical support please have the following information available:

- Device type (name plate/display)
- Serial number (name plate)
- Software version
- Information regarding accessories and options used

If you would like to send the device in for repair please proceed as follows:

- Remove all non-original parts from the device.

NORD accepts no liability for any attached parts such as power cables, switches or external displays.

- Back up the parameter settings before sending in the device.
- State the reason for returning the component/device.
 - You can obtain a return note from our web site ([Link](#)) or from our technical support.
 - In order to rule out the possibility that the cause of a device fault is due to an optional module, the connected optional modules should also be returned in case of a fault.
- Specify a contact person for possible queries.



Information

Factory settings of parameters

Unless otherwise agreed, the device is reset to the factory settings after inspection or repair.

The manual and additional information can be found on the Internet under www.nord.com.

10 Disposal

Incorrect disposal causes damage to the environment! Electronic products and batteries must not be disposed of with household waste. At the end of its life, the product must be properly disposed of according to the local regulations for industrial waste. Use the local collection points.

11 List of abbreviations

FI	Frequency inverter	SPI bus	Serial peripheral interface bus
CSX	SimpleControlBox	IP(44)	International protection
PAR	ParameterBox	ESC	Escape
CTR	ControlBox	DS	Device state
TU	Technology unit	DE	Device error
PC	Personal computer	PLC	Programmable logic controller
EMC	Electromagnetic compatibility	BU	Inverter operating instructions
LCD	Liquid-crystal display	TI	Technical information
LED	Light-emitting diode		
USB	Universal serial bus		
V DC	Direct current		

Key word index

A		
Accessories	13	
adapter.....	50	
Auto-Bus-Scan (P1303).....	66	
B		
Bus scan ParameterBox.....	34	
Bus-Scan (P1001)	59	
C		
Clear memory (P1205)	64	
Contrast (P1304)	66	
ControlBox	32	
ControlBox mode	35	
Controlling with ParameterBox	37	
Copy - Destination (P1202)	63	
Copy - Source (P1201).....	63	
Copy - Start (P1203).....	63	
D		
Data transfer with NORDCON.....	50	
Device characteristics.....	8	
Display-Mode (P1003).....	59	
Documents		
Other applicable.....	73	
E		
Electrician	14	
Error messages	67	
I		
Internet.....	74	
Inverter select (P1002)	59	
K		
Keys ParameterBox.....	36	
L		
Language (P1301).....	65	
		Load default values (P1204)..... 64
M		
Maintenance	74	
Marking	16	
Menu group.....	57	
Menu structure ParameterBox	39, 60	
N		
Name plate.....	17	
NORDAC p-box (P1308).....	66	
NORDCON	50	
O		
Object selection (P1101)	62	
Operating mode (P1302)	65	
P		
Parameterisation with ParameterBox	48	
R		
Reset Boxparameter (P1307).....	66	
S		
Scaling factor (P1005)	61	
Scope of delivery	11	
Set password (P1305)	66	
SK TU5-CTR.....	32	
Software.....	73	
Status window.....	35	
T		
Type code	17	
V		
Values to display (P1004).....	61	
W		
Warning information.....	16	
Warning messages	67	

Headquarters
Getriebebau NORD GmbH & Co. KG
Getriebebau-Nord-Str. 1
22941 Bargtheide, Deutschland
T: +49 45 32 / 289 0
F: +49 45 32 / 289 22 53
info@nord.com