

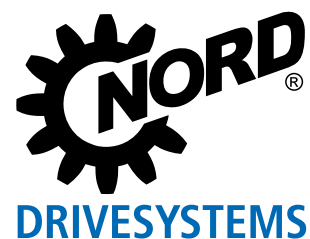

# Motor starter decentralised applications

NORDAC *START* SK 135E series



# Switch on and start working!

## NORDAC *START*, SK 135E series

---



[NORDAC \*START\*](#)

### NORDAC *START*

#### Mains-powered electric motors

are very widespread. They require low installation and commissioning effort.

On the other hand, disadvantages include the high power consumption for the starting torque (up to 7 times the rated current for the motor), excessive mechanical loads on the gear unit and the system, as well as the frequently uncontrolled starting and stopping behaviour. Electronic starters are a simple and very economical solution to this problem. However, NORD devices are far more than simple current limiting “starters” for electric motors.

#### Many applications,

including those in material handling, require electronic starting and stopping of the drive units. The NORDAC *START* is ideally suited for this. Its versatility makes both motor starting functions and soft starting or reversing mode possible. Extensive monitoring functions provide protection from overheating, for example. Due to the I<sup>2</sup>t triggering characteristic, a motor protection switch is not required. Through the integrated line filter, the NORDAC *START*, complies with even the most stringent EMC requirements when mounted on the motor.

### NORDAC *START*

combines the 3 functions of a typical “electronic motor starter”, which are known under the terms starter, reversing starter and soft starter.

The NORDAC *START* provides comprehensive monitoring and protective functions (mains/motor/self-monitoring) and also eliminates the need for a motor protection switch. It enables individual adaptations to the operating characteristics (starting / shut-down behaviour) and provides optional communication interfaces. A special feature is the variable mounting of the device. In confined spaces it has the advantage that the compact device can be easily used for operation close to the motor.

- ▶ Configuration via DIP switches and potentiometers
- ▶ Integrated electronic brake rectifier
- ▶ Choice of different shut-down modes
- ▶ Leakage current <20 mA
- ▶ Consistent parameter structure
- ▶ 2 digital inputs and outputs

### Optional

- ▶ Bus interface on board
  - ▶ AS-Interface (implemented as SK 175E-ASI)
  - ▶ PROFIBUS® DP (implemented as SK 175E-PBR)
- ▶ System plug connectors (e.g. Harting HAN 10E)
- ▶ Variant for ATEX Zone 22 - 3D
- ▶ Various control options (switches, ParameterBox)
- ▶ 24V mains unit

### Variable operating characteristics

- ▶ Pre-defined shut-down modes
- ▶ Variable starting and shut-down ramps
- ▶ Boost function

### EMC Line Filter Class B

- ▶ Integrated line filter
- ▶ Also ideal for applications in a domestic environment, due to compliance with Class B (for motor-mounting or motor cables up to 10 m), or Class A, for wall mounting with motor cables up to 100 m long
- ▶ Suitable for personal protection due to low leakage current (< 20 mA) for operation with universal fault current FI circuit breakers

### Commissioning

- ▶ Commissioning via integrated DIP switches and potentiometer
- ▶ No programming skills required



# Standards and approvals

All devices of the entire series comply with the standards and directives listed below..

Approval	Directive	Applied standards	Certificates	Code
CE (European Union)	Low Voltage Directive 2014/35/EU	EN 60947-1 EN 60529	C310800	
	EMV 2014/30/EU	EN 60947-4-2 EN 63000		
	RoHS Delegated directive (EU) 2011/65/EU 2015/863			
UL (USA)		UL 60947-1 UL 60947-4-2	E365221	
CSA (Canada)		C22.2 No. 60947-1-13 C22.2 No. 60947-4-2-14	E365221	
RCM (Australia)	F2018L00028	EN 60947-1 EN 60947-4-2	133520966	
EAC (Eurasia)	TR CU 004/2011, TR CU 020/2011	IEC 60947-1 IEC 60947-4-2	EAЭC N RU Д-DE. HB27.B.02732/20	
UkrSEPRO (Ukraine)		EN 60947-1 EN 60529 EN 60947-4-2 EN 63000 EN 60947-1 EN 60947-4 EN 61558-1 EN 50581	C311900	
UKCA (United Kingdom)		EN 60947-1 EN 60529 EN 60947-4-2 EN 63000 EN 61800-9-1 EN 61800-9-2	C350800	

Devices which are configured and approved for use in explosion hazard environments comply with the following directives and standards.

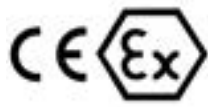
Approval	Directive	Applied standards	Certificates	Code
CE (European Union)	ATEX	2014/34/EU	EN 60079-0 EN 60079-31	C432810  
	EMV	2014/30/EU	EN 63000 EN 60529	
	RoHS	2011/65/EU	EN 60947-1	
	Delegated directive (EU)	2015/863	EN 60947-4-2	

# Type code

## Motor starters

SK 175E-751-340-B (-ASI) (-C) (xxx)

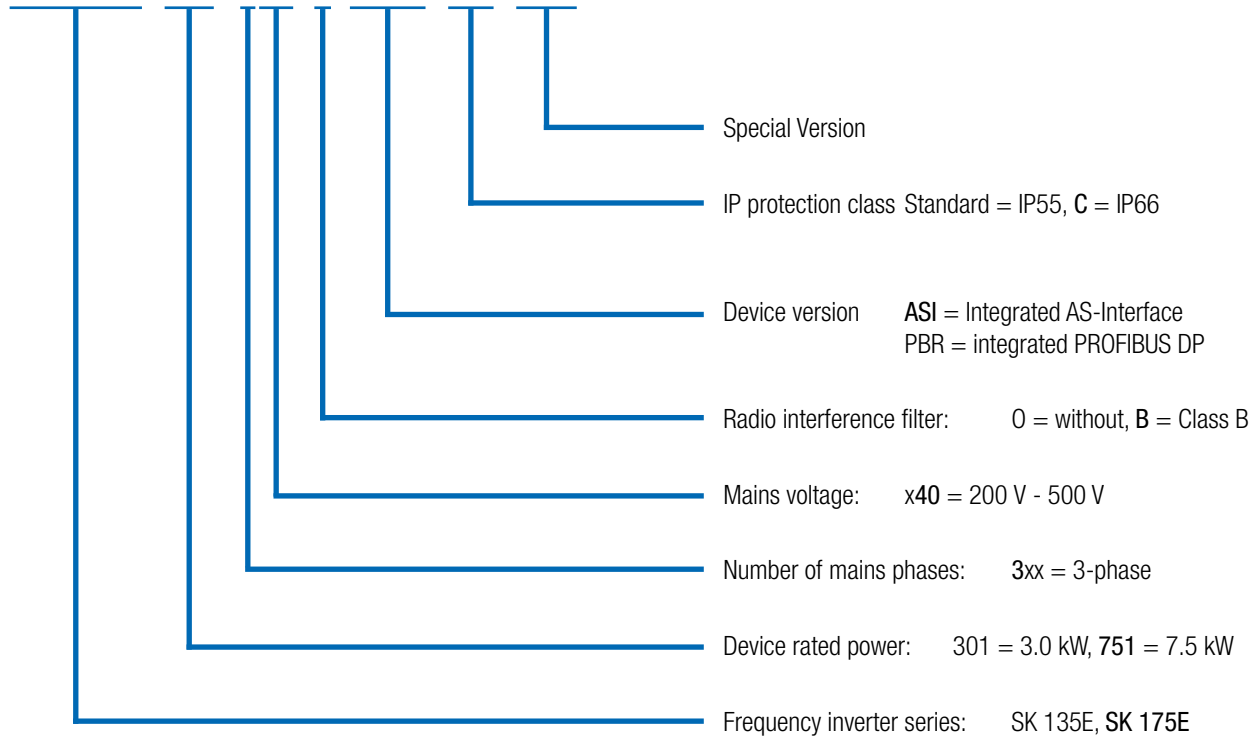

(...) Options, only implemented if required.

# Versatile and sustainable Communication and more

Modern automation systems have a wide range of requirements, so that a suitable bus system and drive components must be selected in order to ensure efficient implementation.

## AS-Interface

For the lower field level, the AS-Interface is a cost-effective solution which enables the networking of binary sensors and actuators. With *NORDAC START*, special versions which provide an appropriate solution by means of an AS-Interface, are available for this price-sensitive area.

The supply voltage (power) is connected separately via the corresponding terminals. Depending on the device configuration (with jumpers), the control voltage of the motor starter is supplied via the yellow AS-Interface cable, or separately via the black (AUX) cable.

Available in all SK 175E ... ASI devices



Power  
(230 V / 400 V)

AS-Interface  
including 24 V supply  
(configurable)

## PROFIBUS DP®

This bus system allows for cyclic exchange of 4 control or 4 status bits via a process data object (with up to 12 Mbps). Addressing is performed via a rotary encoding switch. The PROFIBUS® terminator can be enabled with a jumper. Connection is possible with terminal strips or M12 plug connectors.

Available in all SK 175E ... ASI devices



Jumper Position	AUX	ASI
Slave profile	S-7.A.	S-7.A.
Slave type	A/B-slave	A/B-slave
Control voltage	Black AS-I cable	Yellow AS-I cable
Inputs/Outputs	4/4	4/4
Configuration via DIP-switch	●	●
Configuration via parameters	●	●



### ATEX-compliant drive systems, zone 22 3D

The NORDAC *START* can be modified for operation in explosive environments.

This allows the operation of the motor starter directly in a hazardous area (ATEX 22-3D). The advantages are obvious:

- ▶ Compact drive unit
- ▶ No complex protective devices
- ▶ No motor cables
- ▶ Optimum EMC

Depending on the area of application (conductive or non-conductive dust) the modification also includes the replacement of the transparent diagnostic caps with a version made of aluminium and glass.

It must be noted that operation of the device within the hazardous area is only permitted with integrable modules (SK CU4 modules, internal braking resistors) or specially approved accessories.

There are exceptions for SK TU4 modules, which are described in detail in the manual for the device. Other accessories (e.g. external brake resistors, plug connectors) are not approved for use within a hazardous area.

### Approval

- ▶ According to 2014/34/EU
- ▶ ATEX Zone 22 - 3D
  - ▶ Version for non-conducting dust: IP55
  - ▶ Version for conducting dust: IP66

### Available in all devices





# Motor starter NORDAC *START*

## 3~ 200 ... 500 V

**Typical overload capacity** 150 % for 120 s  
up to 360 s (adjustable)

**Motor starter efficiency** > 98 %

**Ambient temperature** -25 °C...+50 °C (S1),  
-25 °C +60 °C (S3 - 70 % ED)

**Protection class** IP55 optional IP66  
NEMA type1

**IP66 measures**

- ▶ Coated aluminium components
- ▶ Coated circuit boards
- ▶ Low-pressure test

**Protective measures against**

- ▶ Mains phase failure
- ▶ Motor phase failure
- ▶ Flux monitoring
- ▶ Motor over temperature (PTC)
- ▶ Motor overload
- ▶ Mains over/under voltage

**Motor temperature monitoring**

I<sup>2</sup>t Motor  
PTC / bi-metal switch

**Leakage current**

< 20 mA

Motor starters SK 135 E... / SK 175 E...	Nominal motor power		Nominal output current rms [A]	Mains voltage / output voltage	Weight [kg]	(Overall) dimensions L x W x H [mm]
	[kW]	[hp]				
-301-340-B	up to 3.0	up to 4	7.5	3~ 200 V ... 500 V, -10 % / +10 %, 47 ... 63 Hz	2.1	221 x 154 x ca.101
-751-340-B	up to 7.5	up to 10	16.0			

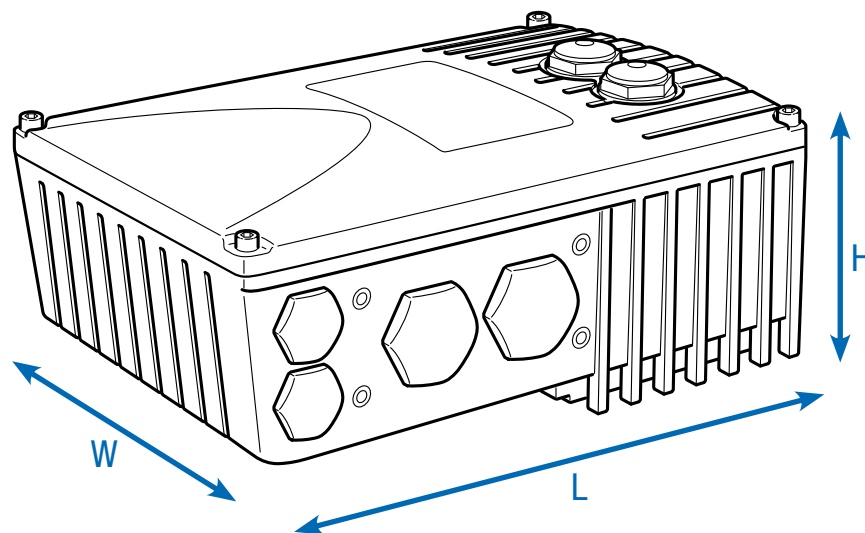

# The entire team

## All device versions at a glance

	SK 135E 0.25 - 7.5 kW	SK 175E - ASI 0.25 - 7.5 kW	SK 175E - PBR 0.25 - 7.5 kW
Soft start function	●	●	●
Reversing function	●	●	●
Motor and wall mounting possible <sup>1</sup>	●	●	●
Energy bus - loop-through of mains supply cables <sup>2</sup>	●	●	●
RS-232 diagnostic interface	●	●	●
Parameters pre-set with standard values	●	●	●
Integrated EMC line filter according to EN 60947-4-2, Class B up to 10 m motor cable and for motor assembly	●	●	●
Integrated EMC line filter according to EN 60947-4-2, Class A up to 100 m motor cable and for motor assembly	●	●	●
Extensive monitoring functions	●	●	●
Brake management for mechanical holding brake	●	●	●
AS-Interface on board	○	●	○
PROFIBUS DP® on board	○	○	●
External 24 V power supply for the control board	●	●	●
Switch variants	●	●	●
Plug connectors for connection of control, motor and mains cables	●	●	●

<sup>1</sup> Wall mounting: wall mounting kit required  
 Motor mounting: an adapter for connection to the motor terminal box may be necessary.

<sup>2</sup> Direct connection to the terminal bar or via system plug connectors

● Available as standard  
 ● Optional  
 ○ Not available

# The senses

## Control connections on the motor starter

	SK 135E 0.25 - 7.5 kW	SK 175E - ASI 0.25 - 7.5 kW	SK 175E - PBR 0.25 - 7.5 kW
Control terminals	Number of digital inputs (DIN)	2	2 (+2 sensor inputs for Bus)
	Number of digital outputs (DOUT)	2	2
	Brake control	●	●
	Temperature sensor (PTC)	●	●
Communication	RS-232 RJ12	●	●
	AS-I terminal connection	○	●
	PROFIBUS DP® terminal connection	○	●

### Note

Control terminals can be added with optional modules (IOs, device protection).

- Available as standard
- Not available

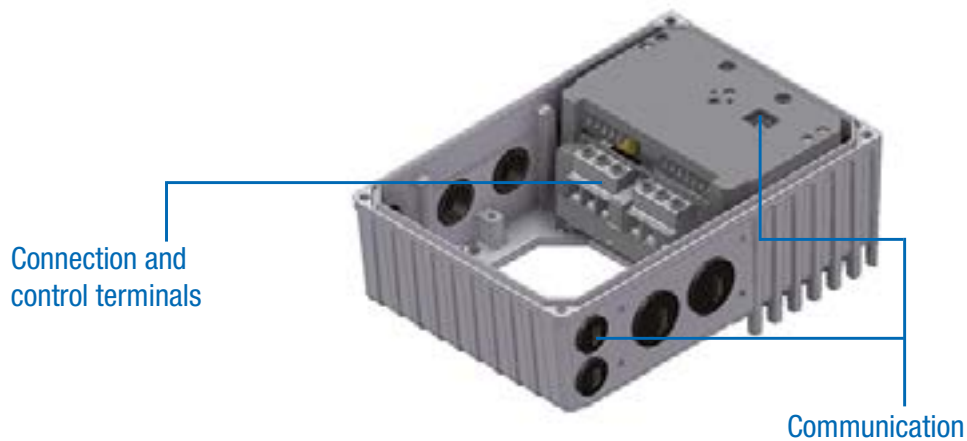

# Configuration and monitoring

## Integrated aids for safe operation

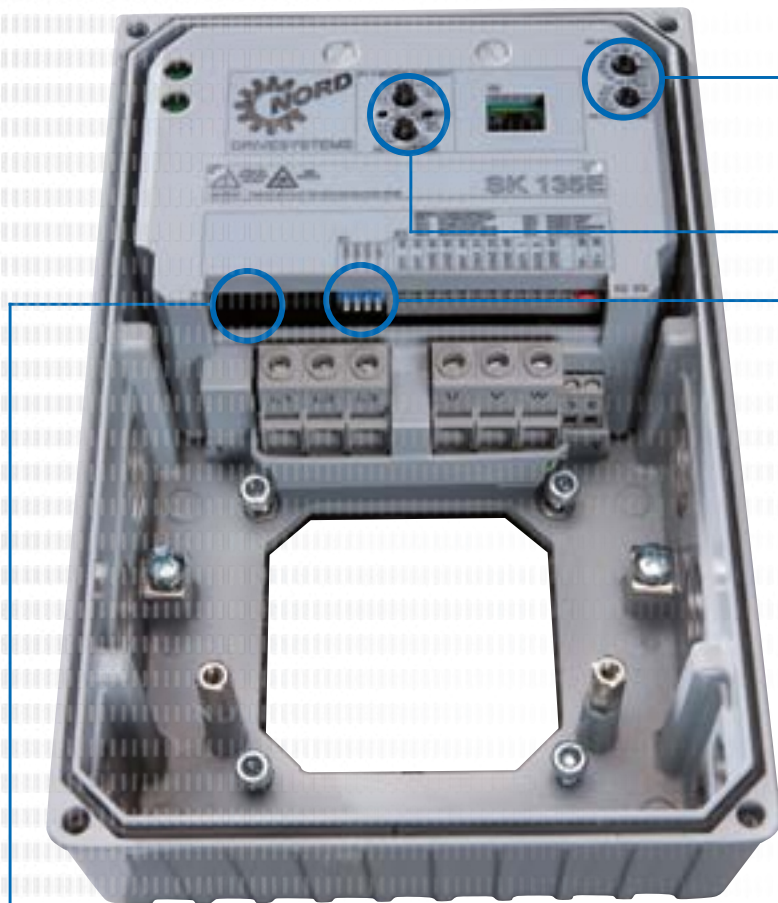

### Commissioning with a screwdriver

Commissioning of the device is basically possible without parameter adaptation, i.e. without programming aids. For this purpose, DIP switches and several 10 step potentiometers are available. These are accessible via the diagnostic opening in the centre or by removing the cover. The status LEDs of the device are also located behind this diagnostic opening.

The following parameters can be adjusted in this way:

- ▶ Rated motor current
- ▶ Locking time
- ▶ Start-up torque
- ▶ Start-up and run-down time
- ▶ Switch-off mode
- ▶ Phase sequence detection
- ▶ Automatic start
- ▶ PROFIBUS DP® addressing (only SK 175E-...-PBR)

### Jumpers for configuration

The communication interface can be configured by changing the jumper position.

- ▶ SK 175E-...-ASI: Communication mode
  - ▶ ASI (supply for interface and device via yellow cable) or
  - ▶ AUX (supply for interface via yellow cable and for device via black cable)
- ▶ SK 175E-...-PBR: Interface terminator

Available in all SK 175E devices

## Status and diagnostic cockpit

Depending on the type of device, various aids for monitoring the device or for diagnosis in case of faults are located behind two transparent cover caps. In addition, there are further elements (e.g. potentiometers or similar) which are useful for “screwdriver-assisted commissioning”



### 1 Status LEDs and potentiometers

In addition to status and readiness indicators, the actual overload level, warnings and error messages of the integrated bus system (SK 175E) are indicated in coded form by the LEDs.

Operational settings of the motor starter can be set with the potentiometers.

### 2 Diagnostic interface, RS-232

RJ12 interface for connection of a diagnostic and parameterisation tool (e.g. PC with NORDCON software, ParameterBox1). Analysis, diagnostics, parameterisation and monitoring of the drive unit via software is possible during commissioning or service.

<sup>1</sup> Use of a parameterisation unit also requires the use of a signal converter. (SK TIE4-RS-485-RS-232, material no. 275 274 603)

# Varied installation possibilities

## Motor Assembly

The motor starter can be mounted directly on the terminal box base of the (geared) motor, thus forming a perfect unit consisting of the drive and the control technology. This motor-mounted format makes full use of its unbeatable advantages: compact overall dimensions of the drive unit, practically immediate readiness for use after connection to the mains supply thanks to the pre-configuration of the drive unit at the factory, optimum EMC due to short cable lengths - or elimination of a motor cable.

## Wall mounting

As an alternative to motor mounting, the device can be mounted close to the motor with the aid of an optional wall mounting kit.

You can select from different versions depending on the prevalent ambient conditions.

### 1. Standard version SK TIE4-WMK-1-K

### 2. ATEX version SK TIE4-WMK-1-EX

This version is functionally comparable to the standard version, however it is suitable for use in explosion hazard environments (ATEX Zone 22 3D).

Designation	Material No.	Frequency inverters <sup>1</sup> for size FI
SK TIE4-WMK-1-K	275 274 004	BG 1
SK TIE4-WMK-2-K	275 274 015	BG 2
SK TIE4-WMK-1-EX	275 175 053	BG 1
SK TIE4-WMK-2-EX	275 175 054	BG 2
SK TIE4-WMK-TU <sup>2</sup>	275 274 002	Typ: SK TU4-

<sup>1</sup> Mounting of the WMK underneath the motor starter

<sup>2</sup> Mounting of the WMK on the connection unit of the technology unit

## Motor-mounted or wall-mounted motor starters

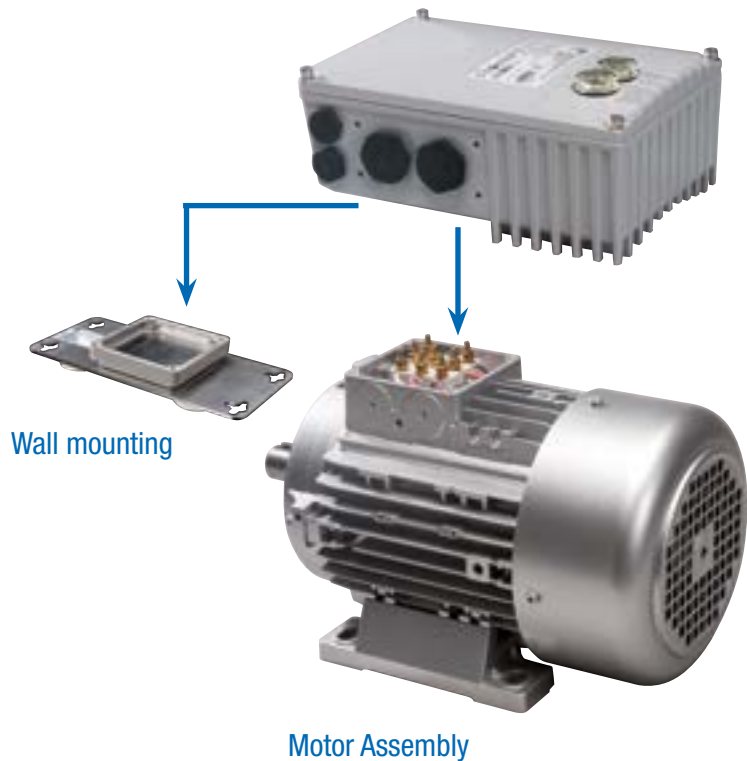

Designation	Material	Integrated fan	Achievable protection class	Weight [kg]	(Overall) dimensions L x W x H [mm]	Remarks
SK TIE4-WMK-1-K	Plastic	-	IP66	0,2	205 x 95 x5	
SK TIE4-WMK-2-K	Plastic	-	IP66	0,3	235 x 105 x 5	
SK TIE4-WMK-1-EX	Stainless steel	-	IP66	0,6	205 x 95 x 4	
SK TIE4-WMK-2-EX	Stainless steel	-	IP66	0,8	235 x 105 x 10	
SK TIE4-WMK-TU	Stainless steel	-	IP66	0,4	155 x 85 x 3	

<sup>1</sup> H = Increase in the total height of the device if mounted on the wall mounting kit

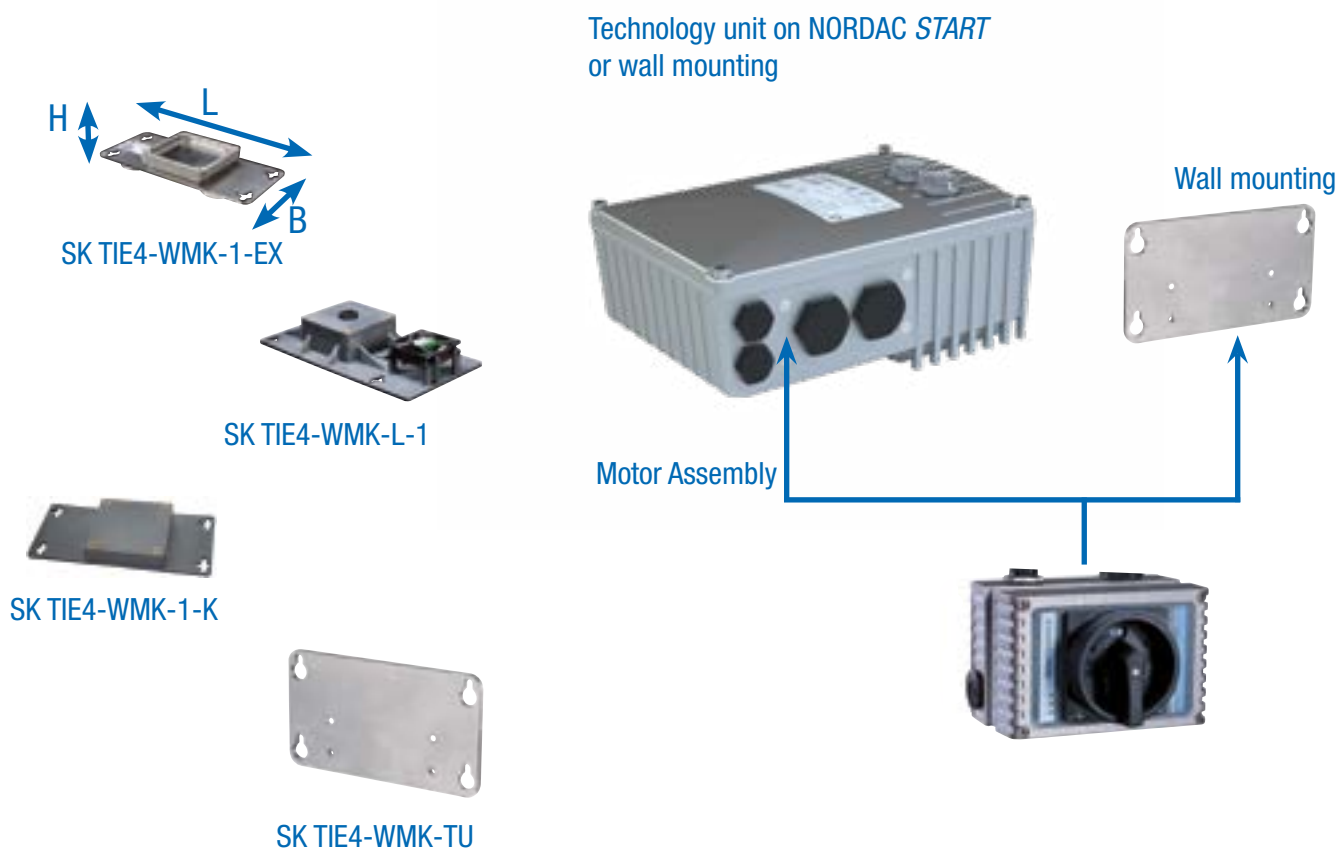





Please find a full range of accessories below that can be equally used for different series. This primarily applies to our decentralised devices of the NORDAC *LINK*, NORDAC *ON*, NORDAC *FLEX*, NORDAC *BASE* and NORDAC *START* series.

---

Operation  
and parameterisation

Seite 18



---

24 V power supply units,  
potentiometers, switches, signal converters  
and more

Page 20



---

System connectors  
for power and control connections

Page 22



---

Connection technology  
Cables



Page 26



# Operation and parameterisation

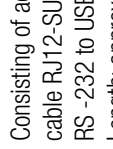

## Control and parameterisation units /software

Designation Material No.	Description	Remarks
 ParameterBox SK PAR-5H 275281614	Control and parameterisation, LCD (illuminated), plain text display in 14 languages, direct control of up to five devices, memory for five device data sets, convenient control keypad, communication via RS-485, including 1.5 m connection cable. Handheld, suitable for installation in a control cabinet door. IP54	Connection for data exchange with <i>NORDCON STUDIO</i> to a PC (USB 2.0), (standard "USB-C" connection cable required, e.g. material number: 275292100) Power supply, e.g. directly via frequency inverter or PC

Designation Material No.	Description	Remarks
 <p>Adapter cable RJ12-SUB-D9 278 910 240</p>	<p>To connect the frequency inverter to the serial interface of a PC via SUB-D9</p>	<p>Length: approx. 3 m</p>
<p>Connection set SK TIE4-RS232-USB 275 274 604</p> 	<p>To connect the frequency inverter to the serial interface of a PC via USB 2.0</p>	<p>Consisting of adapter cable RJ12-SUB-D9 and RS-232 to USB inverter Length: approx. 3 m + 0.5 m</p>
<p>Control and parameterisation software NORDCON</p> 	<p>Software for control and parameterisation as well as commissioning assistance and fault analysis of NORD electronic drive technology. Parameter names in 14 languages</p>	<p>Free download: <a href="http://www.nord.com">www.nord.com</a></p>
<p>NORDAC ACCESS BT Bluetooth-Stick SK TIE5-BT-STICK 275 900 120</p> 	<p>Interface for wireless connection to a mobile terminal device (e.g. tablet or smartphone) via Bluetooth. With the aid of the NORDCON APP, the NORDCON software for mobile terminal devices, enables smart operation and parameterisation as well as commissioning assistance and fault analysis of NORD electronic drive technology.</p>	<p>NORDCON APP available free of charge for Android and iOS</p>

# Supply and control

## 24 V power supply units, potentiometer and switches

Variant	Designation Material No.	Installation Attached / separate Protection class	Description	Remarks	NORDAC		
					FLEX	BASE	START
 Power supplies	SK CU4-24V-123-B 275271 108	● ○ IP20	Output: 24 V DC, 420 mA	For connection to 115 V/230 V devices, including AD converter for evaluation of a 10 kΩ - potentiometer	●	●	●
	SK CU4-24V-123-B-C <sup>1</sup> 275271 608	● ○ IP20	Output: 24 V DC, 420 mA		●	●	●
	SK CU4-24V-140-B 275271 109	● ○ IP20	Output: 24 V DC, 420 mA	For connection to 400 V/500 V devices, including AD converter for evaluation of a 10 kΩ - potentiometer	●	●	●
	SK CU4-24V-140-B-C <sup>1</sup> 275271 609	● ○ IP20	Output: 24 V DC, 420 mA		●	●	●
 Power supplies	SK TU4-24V-123-B 275281 108	○ ● IP55	Output: 24 V DC, 420 mA	For connection to 115 V/230 V devices, including AD converter for evaluation of a 10 kΩ - potentiometer plus suitable connection unit SK T14-TU-NET/SK T14-TU-NET-C	●	●	●
	SK TU4-24V-123-B-C 275281 158	○ ● IP66	Output: 24 V DC, 420 mA		●	●	●
	SK TU4-24V-140-B 275281 109	○ ● IP55	Output: 24 V DC, 420 mA	For connection to 400 V/500 V devices, including AD converter for evaluation of a 10 kΩ potentiometer plus suitable connection unit SK T14-TU-NET/SK T14-TU-NET-C	●	●	●
	SK TU4-24V-140-B- 275281 159	○ ● IP66	Output: 24 V DC, 420 mA		●	●	●
 Connection units	SK T14-TU-NET 275280 100	○ ● IP55		SK TU4-... connection unit for power supply units (IP55)	●	●	●
	SK T14-TU-NET-C 275280 600	○ ● IP66		SK TU4-... connection unit for power supply units (IP66)	●	●	●
	SK TIE4-WMK-TU 275274 002	○ ○ IP66		For separate mounting of SK TU4... modules with SK T14-TU-...	●	●	●

- Available as standard
- Not available

<sup>1</sup> Version with varnished circuit boards for applications in IP6X devices

Variant	Designation Material No.	Installation	Attached / separate Protection class	Description	Remarks
	SK TIE4-SWT 275 274 701	<input type="radio"/>	<input checked="" type="radio"/> IP66	Switch	"ON R" - "OFF" - "ON L"
Switch	SK TU4-MSW 275 281 123	<input type="radio"/>	<input checked="" type="radio"/> IP55	1 ~ 100 - 240 V / 3 ~ 200 - 500 V, 16 A	Switch to disconnect the device from the power supply, black twist grip plus suitable SK T14-TU-MSW/SK T14-TU-MSW-C connection unit
	SK TU4-MSW-C 275 281 173	<input type="radio"/>	<input checked="" type="radio"/> IP66	1 ~ 100 - 240 V / 3 ~ 200 - 500 V, 16 A	
Connection units	SK T14-TU-MSW 275 280 200	<input type="radio"/>	<input checked="" type="radio"/> IP55		SK TU4-... connection unit for maintenance switches (IP55)
	SK T14-TU-MSW-C 275 280 700	<input type="radio"/>	<input checked="" type="radio"/> IP66		SK TU4-... connection unit for maintenance switches (IP66)
	SK TIE4-WMK-TU 275 274 002	<input type="radio"/>	<input type="radio"/> IP66		For separate mounting of SK TU4... modules with SK T14-TU-...

- <sup>1</sup> Version with varnished circuit boards for applications in IP6X devices
- Available as standard
  - Not available

# Perfect connections with system plug connectors

The use of optionally available plug connectors for power and control connections not only makes it possible to replace the drive unit with almost no loss of time in case of servicing, but also minimises the danger of installation errors when connecting the device. This enables the perfect construction of an energy or communication bus. Typical plug connector versions are summarised below.



## Plug connectors for power connections

Plug connectors from various manufacturers are available for the motor or mains connection for rated currents of up to 20A.

Type	Data	Designation	Material No.
Input (power and control voltage)	400 V, 16 A + 24 V, 4 A	SK TIE4-HANQ4-M-LE-MX	275 274 113
Input and output (power and control voltage)	400 V, 32 A + 24 V, 4 A	SK TIE4-2HANQ4-M-LE-LA	275 274 112
Input and output (power and control voltage)	400 V, 40 A + 24 V, 6 A	SK TIE4-2HANQ4-M-LE-LA-6mm	275 274 119
Power input	500 V, 16 A	SK TIE4-HAN10E-M1B-LE	275 135 070
Power input	500 V, 16 A	SK TIE4-HAN10E-M2B-LE	275 135 000
Power input	500 V, 16 A	SK TIE4-HANQ8-M-LE-MX	275 135 030
Power input	690 V, 20 A	SK TIE4-QPD4SPM	275 274 185
Power output	500 V, 16 A	SK TIE4-HAN10E-M2B-LA	275 135 010
Power output	500 V, 16 A	SK TIE4-HANQ8-M-LA-MX	275 135 040
Motor output	500 V, 16 A	SK TIE4-HAN10E-M2B-MA	275 135 020
Motor output	500 V, 16 A	SK TIE4-HANQ8-M-MA-MX	275 135 050
Power input + motor or power output	400 V, 16 A	SK TIE4-2HANQ5-K-LE-LA	275 274 110



## Plug connectors for control connections

Various M12 round plug connectors are available as flanged plugs or flanged sockets. The plug connectors are intended for installation in an M16 screw fitting on the device and can be oriented in any direction. The protection class (IP67) of the plug connector only applies in the screwed state. The cover caps correspond to the colour version as does the plastic body of the plug connector. Expansion and reducer adapters are available for installation in an M12 or M20 screw fitting.



Type	Version	Designation	Material No.
Power supply	Plug connectors	SK TIE4-M12-POW	275 274 507
Sensors/actuators	Bushing	SK TIE4-M12-INI	275 274 503
Sensors/actuators	Plug connectors	SK TIE4-M12-INP	275 274 516
AS-Interface	Plug connectors	SK TIE4-M12-ASI	275 274 502
AS-Interface – Aux	Plug connectors	SK TIE4-M12-ASI-AUX	275 274 513
PROFIBUS® (IN + OUT)	Connector + socket	SK TIE4-M12-PBR	275 274 500
Connection extension	M12 - M16	SK TIE4-M12-M16	275 274 510
Connection reduction	M20 – M16	SK TIE4-M20-M16	275 274 511



# Installation locations for system connectors

## System connectors

The devices provide various screw fittings which can be used for the installation of cable glands or system connectors. Screw-in reduction or expansion adapters enable the connection of additional cable cross sections as required.

### NORDAC *BASE* and NORDAC *START*

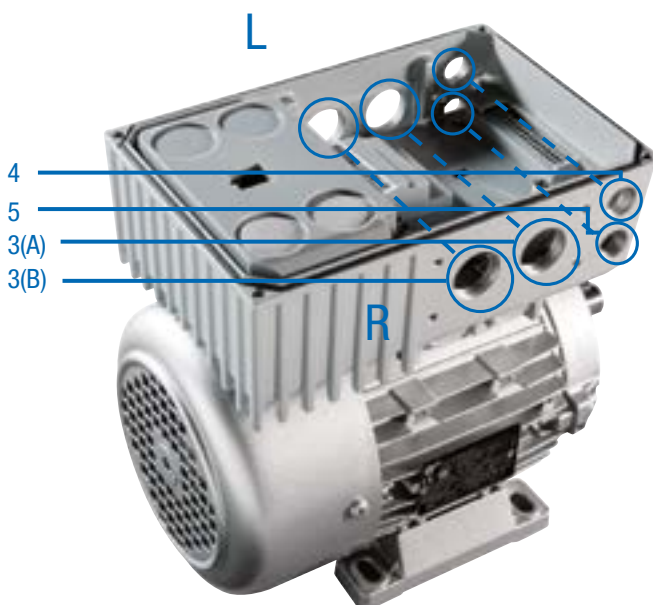

### Option locations (R or L assignment, view towards the motor fan)

- 3 L/R 2 x M25 screw fitting (A/B)
- 4 L/R M16 screw fitting
- 5 L/R M16 screw fitting

The plug connectors for the power connection are installed at position 3 (R or L).



## Connection unit - Technology Unit

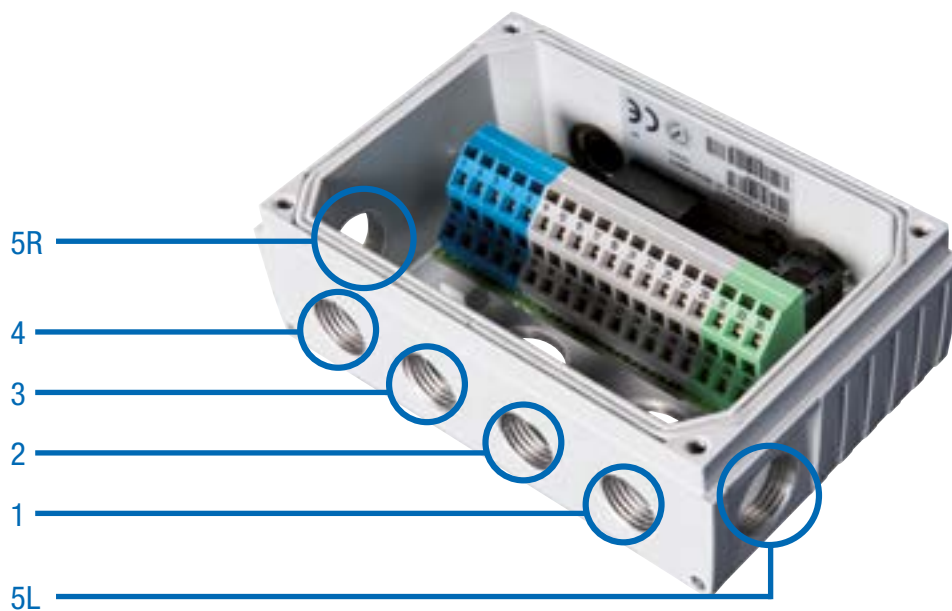

### Optionsplätze der SK TI4-TU-...

- 1 M16 screw fitting
- 2 M16 screw fitting
- 3 M16 screw fitting
- 4 M16 screw fitting
- 5 L/R M20 screw fitting



# Not to be underestimated – the correct connection method

With the NORDAC *LINK*, *FLEX*, *BASE* and *START* frequency inverters and motor starters, the NORD DRIVESYSTEMS Group provides the right product for motor control for all decentralised drive technology applications. The advantages, such as short motor cables, improved EMC and installation without control cabinets are obvious.

Connection of the decentralised components (motor and electronics) is made either with a permanent connection with cable glands<sup>1</sup> or can be in the form of plug connectors. However, the full advantages of decentralised drive technology are only achieved with the selection of plug-in connectors.

- ▶ Quick and simple electrical connection
- ▶ Minimisation of connection errors
- ▶ Minimum installation effort for installation, maintenance and servicing
- ▶ Reduced downtime in case of replacement

NORD supplies an extensive range of connection and control cables.

- ▶ Depending on the version, connecting cables include power connection cables (mains and motor) and if necessary cables for thermistors as well as 24 V DC control voltage.
- ▶ Control cables are exclusively used for transmitting control signals (encoder, bus, IO signals).

Connection and control cables are supplied pre-assembled. They are available in various lengths and can optionally be provided with open ends or plug connectors. Typically, all cables<sup>2</sup> are shielded.

<sup>1</sup> Not for NORDAC *LINK*, NORDAC *ON*

<sup>2</sup> Except for mains connection/daisy chain cables



# Designation of pre-assembled cables

## Pre-assembled cables

- ▶ Cables for motor and frequency inverter connection
- ▶ Mains connection and signal cables
- ▶ Customised plug connectors and cable lengths

## SC H4G2.5 HQ8SMM H10E1SMF 1.5 UL

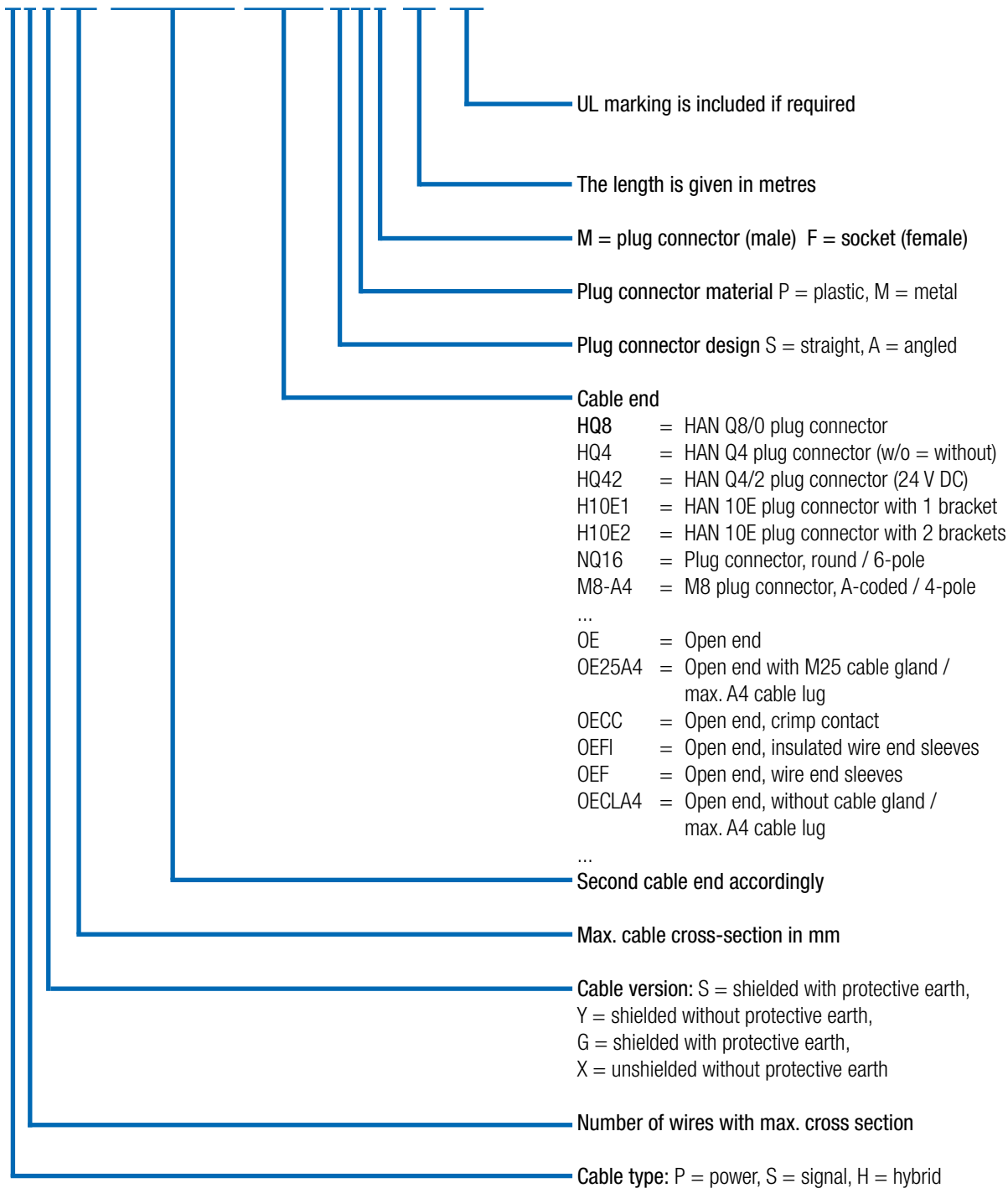

# Technical data cables

The design depends on the ambient conditions and the type of installation and must be decided by the customer. All options can be requested from NORD according to the specific project.

Feature	Standard	Options
Conductor material	Copper	-
Installation type	Permanent installation	-
Cable insulation	Polyvinyl chloride (PVC)	Polyurethane (PUR)
Protective sleeve	No	On request
Cable length	Motor cables: 1.5 m – 3.0 m – 5.0 m Mains cables: 1.5 m – 3.0 m – 5.0 m Daisy chain cables: 1.5 m – 3.0 m – 5.0 m Encoder cables: 1.5 m – 3.0 m – 5.0 m Brake resistor cables: 2.0 m – 3.0 m	On request

# Motor cables

## Product overview – Motor cables

Depending on the motor, the following shielded motor connection cables are available.

### NORDAC LINK, FLEX, BASE, START

Designation	Motor power [kW]	Certification	Part number for length [m]		
			1.5	3	5
SC H4S2.5 HQ8SPM OE20A4 UL	0,12 - 0,37	EU / UL	275 274 800	275 274 801	275 274 802
SC H4S2.5 HQ8SPM OE25A4 UL	0,55 - 1,5	EU / UL	275 274 805	275 274 806	275 274 807
SC H4S2.5 HQ8SPM OE32A4 UL	2,2 - 3,0	EU / UL	275 274 825	275 274 826	275 274 827
SC H4S2.5 HQ8SPM OE32A5 UL	4,0	EU / UL	275 274 830	275 274 831	275 274 832
SC H4S4 HQ8SPM OE32A6 UL	5,5 - 9,2	EU / UL	275 274 835	275 274 836	275 274 837
SC H4S2.5 HQ8SPM H10E1SMF	0,12 - 4,0	EU	275 274 810	275 274 811	275 274 812

### NORDAC ON

Designation	Motor power [kW]	Certification	Part number for length [m]		
			1.5	3	5
SC H4S1 ST8SMM OE20A4 UL	63 – 71 IE1 - IE3	EU / UL	275 274 690	275 274 691	275 274 692
SC H4S1 ST8SMM OE20A4 UL WOB <sup>1</sup>	63 – 71 IE1 - IE3	EU / UL	275 274 617	275 274 618	275 274 619
SC H4S1 ST8SMM OE25A4 UL	80 – 90 IE1 - IE3 71 IE5+	EU / UL	275 274 695	275 274 696	275 274 697
SC H4S1 ST8SMM OE25A4 UL WOB <sup>1</sup>	80 – 90 IE1 - IE3 71 IE5+	EU / UL	275 274 621	275 274 622	275 274 623
SC H4S1 ST8SMM HQ8SMF UL	NORD Motorstecker „MS21“	EU / UL	275 274 685	275 274 686	275 274 687
SC H4S1.5 TEH51SVM TEH51SVF MBE <sup>2</sup>		EU / UL	in preparation	in preparation	in preparation

### Frequency inverter/Motor starter connection



### Motor connection



Open ends

### Required motor option<sup>1</sup>

ZKK



MS31 or MS31E

<sup>1</sup>For further information about motor options please refer to motor catalogue M7000

# Mains cables / Daisy chain cables

## Product overview – Mains cable

The following unshielded mains cables are available. A simple plug-in connection for frequency inverters can be achieved with the HQ4 variant. With a further variant (HQ42) a 24 V DC supply can also be implemented.

Designation	24 V DC supply	Certification	Part number for length [m]		
			1.5	3	5
SC P4G2.5 HQ4SPF OE	no	EU	275 274 840	275 274 841	275 274 842
SC P4GA14 HQ4SPF OE UL	no	UL		275 274 241	275 274 242
SC H4G4 HQ42SPF OE	yes	EU	275 274 845	275 274 846	275 274 847
SC H4GA12 HQ42SPF OE UL	yes	UL		275 274 246	275 274 247
SC H6G2.5 NQ16SPF OE UL <sup>1</sup>	yes	UL	275 274 218	275 274 219	275 274 220

<sup>1</sup> only NORDAC *ON*



## Product overview – Daisy chain cables

A daisy chain cable is designed for looping the mains connection (plug connections on both sides) from one frequency inverter to the next. The variants as for mains cables are available. These cables are also unshielded.

Designation	24 V DC supply	Certification	Part number for length [m]		
			1.5	3	5
SC P4G4 HQ4SPM HQ4SPF	no	EU	275 274 850	275 274 851	275 274 852
SC P4GA12 HQ4SPM HQ4SPF UL	no	UL		275 274 251	275 274 252
SC H4G4 HQ42SPM HQ42SPF	yes	EU	275 274 855	275 274 856	275 274 857
SC H4GA12 HQ42SPM HQ42SPF UL	yes	UL		275 274 256	275 274 257
SC H6G2.5 NQ16SPM NQ16SPF UL <sup>1</sup>	yes	UL	275 274 288	275 274 289	275 274 290

<sup>1</sup> only NORDAC *ON*



# Brake resistor cable / Control cables

## Product overview – Braking resistor cables

The following shielded cables are available for connecting an external brake resistor

Designation	Certification	Part number for length [m]	
		2	3
SC P3S2.5 HQ2SPM OE	EU	275 274 881	275 274 899
SC P3SA14 HQ2SPM OE UL	UL	275 274 280	275 274 281



## Product overview – Control cables

Control cables for connection to an encoder are typically connected with so-called "M12 plug connectors". The following system solutions are available for encoder connection.

Designation	Motors			Encoders <sup>1</sup>	Cable type	Control cable Length - Part No.
	IE1-3	IE4	IE5+			
AG4 cable set consisting of 1x each SK CE-A5F-AGC-A5F SK CE-B4M-IGC-B5F	●	●	○	AG4 - 19 551 886	AG4 cable set	1.5 m - 275 274 640 3.0 m - 275 274 641 5.0 m - 275 274 642
SC S4Y0.25 M12-B4MM M12-A8SMF	●	○	○	IG12P - 19 651 501 IG22P - 19 651 511 IG42P - 19 651 521	HTL without zero track	1.5 m - 275 274 675 3.0 m - 275 274 676 5.0 m - 275 274 677
SC S5S0.25 M12-A5SPM M12-A5SPF	○	●	○	IG22P5 - 19 651 910	HTL with zero track	1.5 m - 275 274 874 3.0 m - 275 274 876 5.0 m - 275 274 877
	○	○	●	IG62P5 - 19 605 002		
SC S5Y0.25 M12-A5SMM M12-A8SMF	○	●	○	IG22P8 - 19 651 911	HTL with zero track	1.5 m - 275 274 645 3.0 m - 275 274 646 5.0 m - 275 274 647

- Available as standard
- Not available

<sup>1</sup> Further information about encoders can be obtained from motor catalogue M7000.

**Headquarters:**

Getriebebau NORD GmbH & Co. KG

Getriebebau-Nord-Str. 1

22941 Bargteheide, Deutschland

T: +49 (0) 45 32 / 289 - 0

F: +49 (0) 45 32 / 289 - 22 53

[info@nord.com](mailto:info@nord.com)