

SK TI4-TU-SAFE-C

Part number: 275 280 800

Connection unit

NOTICE

Validity of this document

This document is only valid in combination with the operating instructions for the relevant frequency inverter. All of the information that is relevant for a safe start-up of this module and the frequency inverter is only available under these conditions.

Scope of supply

1 x	Connection unit	SK TI4-TU-SAFE-C
1 x	Gasket	2 mm, self-adhesive
2 x	Lead through grommet	22 mm x 9.5 mm
4 x	Hexagon socket	M4 x 20
1 x	Diaphragm valve	M12x1.5 RAL9005
1 x	Reducer (brass)	M20 → M12
Cable sets ¹⁾		
1 x	PE (gn/ye)	1 x Ø 1.5 mm ² , length 100 mm
1 x	Systembus (bk, gy)	2 x Ø 0.25 mm ² , length 250 mm
1 x	Encoder (wh, gy, bu)	3 x Ø 0.50 mm ² , length 250 mm
1 x	Safe stop (bk (1), bk (2))	2 x Ø 0.50 mm ² , length 300 mm
1 x	Voltage supply ²⁾ (bu, bn)	2 x Ø 0.50 mm ² , length 250 mm

1) SK 2xxE: 100 mm longer for devices size 4, exception PE.

2) Only for SK 215E / SK 235E.



Field of use

The connection unit forms the basis for the bus options PROFIsafe[®] of model **SK TU4-PNS(-M12)-C**. It may only be operated with this bus option in order to avoid damage to the connection unit or bus option.

The terminal strip is divided into three parts. The functions of the individual terminals are not defined until both elements are joined together (connection unit and field bus). The connection unit can be fitted to or in the immediate vicinity of a frequency inverter (SK 2xxE).

Technical data

Temperature range	-25 °C ... 40 °C
Temperature class	Class 3K4
Protection class	IP66
Vibration resistance	3M7
Dimensions [mm]	H x W x D: 95 x 136 x 55

Current rating	3 A
Cable cross section	AWG 26-14
rigid	0.14 - 2.5 mm ²
flexible with wire end ferrules	0.14 - 1.5 mm ²

Technical Information / Datasheet		SK TI4-TU-SAFE-C			
Connection unit		TI 275280800	V 1.3	1618	en

Features

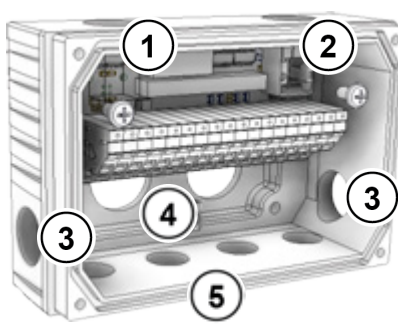
1.	No function, M20 x 1,5	
2.	Diagnosis access, RJ12 socket, , M20 x 1,5	
3.	Cable entry M20 x 1.5 (1 on left, 1 on right, option location 5L and 5R): e.g. For the connection of control and signal lines.	
4.	Cable entry M25 x 1.5 (2 pcs.): Leadthrough for wiring between optional assembly and device (frequency inverter) with direct attachment.	
5.	Cable entry M16x1.5 (4 pcs., option location 1 to 4): e.g. for the connection of control and signal lines.	

Information

M12 connector

NORD can supply prefabricated M12 connection expansions for manufacturing plug-in connections.

These can be screwed directly into the M16 cable lead-ins. The two existing side cable lead-ins (M20) can be used if a suitable reducer is used ([TI 275274511](#)).

Installation

Installation location	To the left or right of the device. Alternatively: near by the device by using the wall mounting kit SK TIE4-WMK-TU (TI 275274002).
Mounting	Using screw connection (4 x hexagon socket M4 x 20)

ATTENTION



Sealing

Ensure that no leaks are present during installation (assembly, cable leadthroughs, cable glands) in order to avoid penetration by moisture and therefore the risk of corrosion and short circuiting.

Installation steps for attachment to the device

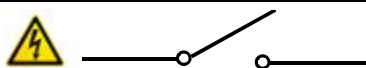
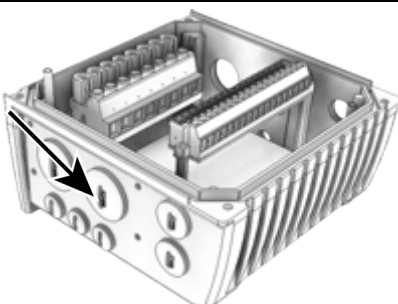

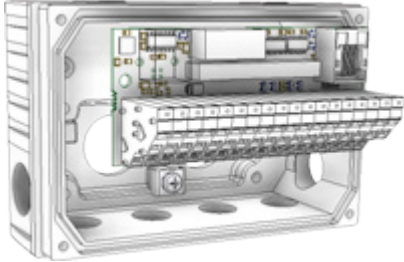
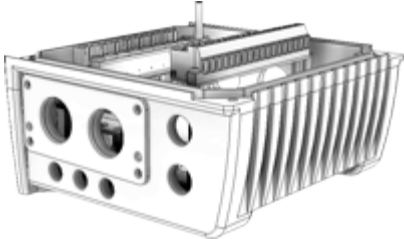
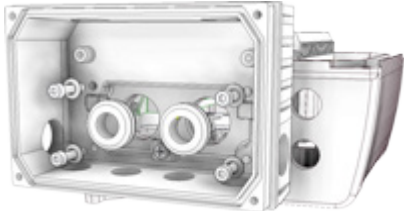

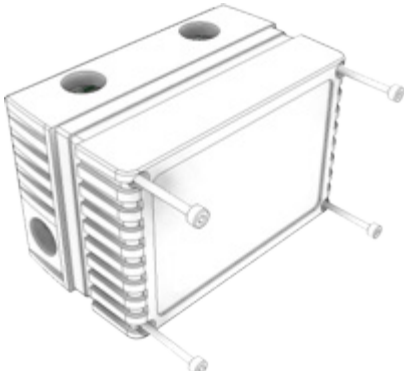
1.	Switch off the mains power.	
2.	Remove the two M25 blind caps from the relevant side of the frequency inverter (right / left).	

3.	<p>Remove circuit board (with terminal strip) from connection unit SK TI4-TU-....</p>	
4.	<p>Fit provided seal to the device..</p>	
5.	<p>Fit SK TI4-TU-.... connection unit to device with the 4 provided screw bolts. Insert both of the provided leadthrough grommets into the M25 leadthroughs (to protect internal wiring between assembly and device).</p>	
6.	<p>Re-install circuit board (see point 3) and make the electrical connection.</p>	
7.	<p>Fit SK TU4- assembly and screw in place.</p>	

Wall mounting assembly steps

(Wall mounting kit SK TIE4-TU-WMK optionally available)

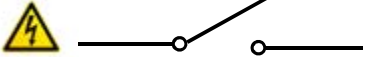

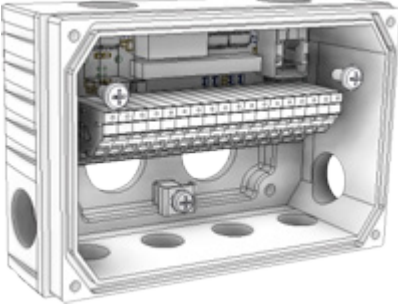
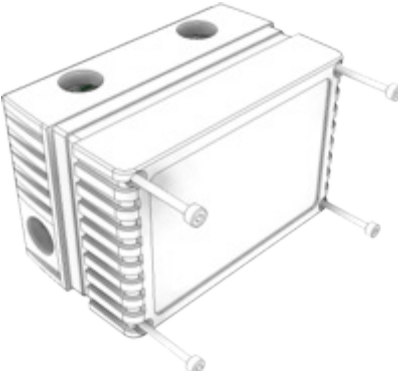
1.	Switch off the mains power.	
2.	Install provided seal to SK TI4-TU-.... connection unit.	
3.	Attach SK TI4-TU-.... connection unit to wall mounting kit. Screw the 2 cheese-head screws (wall mounting kit accessory pack) into the provided holes (countersunk) from the outside.	
4.	Insert the two screw bolts (wall mounting kit accessory pack) into the freely accessible holes in the rear panel from the inside and screw in place.	
5.	Install unit at usage location and make electrical connection (cable length max. 20 m).	
5.	Attach SK TU4- assembly and screw in place.	

 Information

Contacting

The connection between the field bus or IO - expansion and the connection unit is made using a socket board. The terminals of the terminal strip in the connection unit with identical potential are not connected to each other until the field bus or IO - expansion and the connection unit are connected to each other.

ATTENTION

IP66 addition

To protect the assembly from condensation, the provided diaphragm valve must be screwed in. In order to do this, remove the uppermost M20 cable screw connection and screw in the reducer that is also included in the scope of delivery.

The diagnosis access (transparent screw connection) may not be used for this purpose.

Connections

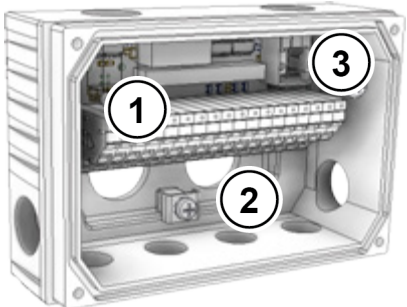
1	Terminal strip	Double tension spring terminal strip	2 x 18 contacts	
2	PE connection	via housing	If fitted to the device (e.g. frequency inverter): make connection to PE of device using the cable (green / yellow).	
3	Diagnosis	RJ12 socket	Interface for connecting parametrisation tool	

Details of the functional assignment of the terminals can be found in the technical information of the relevant bus option or IO expansion of the SK TU4-.

Additional documentation and software (www.nord.com)

Document	Name
TI 275274002	Wall mounting kit for SK TIE4-WMK-TU

Document	Meaning
Various	Data sheets for M12 - connection expansions